

Spring
Scheme of learning

Year 6

White Rose
MATHS

#MathsEveryoneCan

Spring Block 1

Ratio

Small steps

Step 1

Add or multiply?

Step 2

Use ratio language

Step 3

Introduction to the ratio symbol

Step 4

Ratio and fractions

Step 5

Scale drawing

Step 6

Use scale factors

Step 7

Similar shapes

Step 8

Ratio problems



Small steps

Step 9

Proportion problems

Step 10

Recipes



Add or multiply?

Notes and guidance

In this small step, children explore the fact that the relationship between two numbers can be expressed additively or multiplicatively. For example, the relationship between 3 and 9 can be expressed as an addition ($3 + 6 = 9$) or a multiplication ($3 \times 3 = 9$). Children use this understanding to complete sequences of numbers, deciding whether each relationship is additive or multiplicative.

Children also explore the inverse relationships related to each of these, for example $9 - 6 = 3$ and $9 \div 3 = 3$. Using language such as “3 times the size” and “a third of the size” will support their understanding of multiplicative relationships.

Children will explore these relationships using double number lines and should be encouraged to explore all of the additive and multiplicative links that can be seen.

Things to look out for

- Children may see just additive relationships and not notice the multiplicative relationships.
- Children may not start double number lines from zero.
- When using double number lines, children may focus on the horizontal relationships and not notice the vertical relationships.

Key questions

- How can you describe the relationship between these two numbers using addition/multiplication?
- What is the inverse of addition/multiplication?
- What addition/subtraction/multiplication/division calculations can be written from this information?
- Is the relationship in the sequence additive or multiplicative?
- How do the relationships on the upper number line relate to those on the lower number line?

Possible sentence stems

- _____ \times _____ = _____ and _____ + _____ = _____
- _____ is _____ times the size of _____
- _____ is $\frac{\square}{\square}$ the size of _____

National Curriculum links

- Solve problems involving the relative sizes of two quantities where missing values can be found by using integer multiplication and division facts

Add or multiply?

Key learning

- The relationship between 2 and 8 can be described as additive or multiplicative.

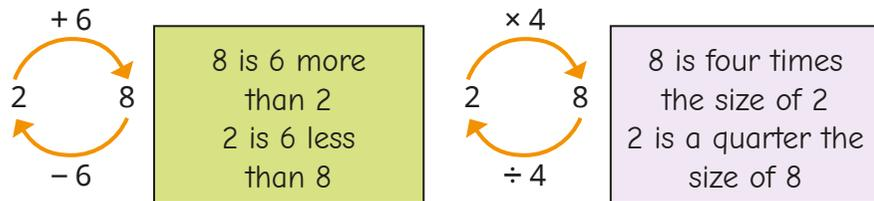

Complete the models to show the additive and multiplicative relationships.



Describe the relationships to a partner.

- A sequence starts 3, 6 ...
 - Explain why the next number could be 9
 - Explain why the next number could be 12
 - What could the next number be in these sequences?

5, 10 ...	7, 21 ...	100, 50 ...
-----------	-----------	-------------

Find two answers for each.

- Complete the sequences.

- ▶ 4, 8, _____, 32, _____, _____
- ▶ _____, 14, 21, 28, _____, _____
- ▶ 1, _____, _____, 27, 81, _____

Are the relationships additive or multiplicative?
Could they be both?

- The double number line shows the relationship between two sets of numbers.

Fill in the missing values to describe the relationships.

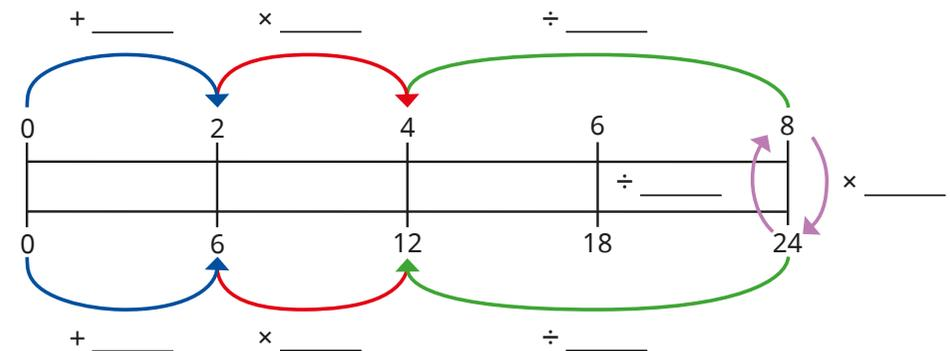

What other additive and multiplicative relationships can you see on the double number line?

Add or multiply?

Reasoning and problem solving

6

12

2

4

8

4

12

20

Each of these sequences can be completed using either addition or multiplication.

Do you agree with Tiny?
Explain your answer.

No

Here are the different options in a pizza shop.

Base	Topping
Thin	Cheese and tomato
Deep pan	Vegetarian feast
	Chicken
	Meat feast

Use both additive and multiplicative reasoning to explain why there are 8 possible combinations of base and topping.

The restaurant introduces a new topping of tuna and sweetcorn. How many combinations are there now?

How many combinations would there be with 4 base options and 17 topping options?

Did you use additive or multiplicative relationships to work out each answer?

10

68

© White Rose Education 2022

Use ratio language

Notes and guidance

In this small step, children are introduced to the idea of ratio representing a multiplicative relationship between two amounts.

Children see how one value is related to another by making simple comparisons, such as: “For every 2 blue counters, there are 3 red counters.” A double number line can be used to show such relationships, building up to recognise that this example is equivalent to 4 blue, 6 red or 20 blue, 30 red and so on. At this point, relationships will only be expressed in words and the ratio symbol will be introduced in the next step.

Children move on to expressing relationships more simply. For example, if there are 10 red and 15 blue counters, these can be physically rearranged so that “For every 2 red counters, there are 3 blue counters.” Children can link this to dividing by a common factor, 5, and relate this to their understanding of simplifying fractions.

Things to look out for

- Children may use additive rather than multiplicative relationships to make comparisons, for example “There is one more blue than red.”

Key questions

- How can you give the relationship between the number of _____ and the number of _____?
- For every _____, how many _____ are there?
- How can you rearrange the counters to make the ratio simpler?
- What number is a common factor of _____ and _____? How can you use this to make the ratio simpler?
- How many _____ would there be if there were _____?

Possible sentence stems

- For every _____, there are _____
- If there were _____, there would be _____
- A common factor of _____ and _____ is _____

National Curriculum links

- Solve problems involving the relative sizes of two quantities where missing values can be found by using integer multiplication and division facts

Use ratio language

Key learning

- Complete the sentences to describe the counters.

There are _____ red counters and _____ yellow counters.

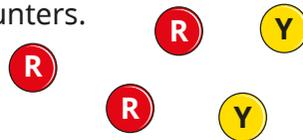

For every _____ red counters, there are _____ yellow counters.

For every _____ yellow counters, there are _____ red counters.

- Complete the sentence to describe the counters.



For every _____ red counters, there is _____ yellow counter.

Can you complete it a different way?

- Complete the sentences to describe the cubes.

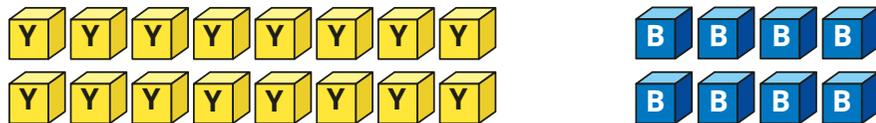

For every 16 yellow cubes, there are _____ blue cubes.

For every 8 yellow cubes, there are _____ blue cubes.

For every 1 blue cube, there are _____ yellow cubes.

- Amir is using a double number line to find equivalent ratios.

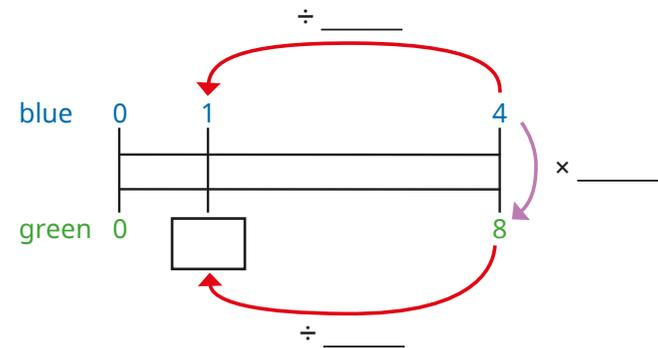

- Use Amir's number line to help you complete the sentence.

For every 1 blue counter, there are _____ green counters.

- Use a double number line to complete the sentences.

For every 4 green counters, there are _____ blue counters.

For every _____ blue counters, there are 16 green counters.

- Complete the sentences to describe the fruit.



For every _____ pears, there are _____ bananas.

For every _____ pears, there are _____ apples.

Use ratio language

Reasoning and problem solving

Jack puts red and yellow tiles in this pattern.



I have 16 more red tiles and 20 more yellow tiles.

Can Jack continue this pattern without there being any tiles left over?

Explain your answer.

No

There are 2 red tiles for every 3 yellow tiles.

16 red tiles will need 24 yellow tiles.

Decide if each statement is true or false.

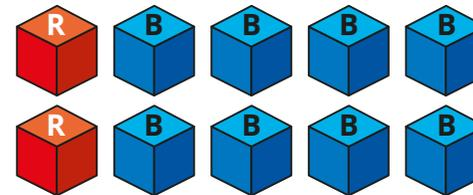

For every red cube, there are 8 blue cubes.

For every 4 blue cubes, there is 1 red cube.

For every 3 red cubes, there would be 12 blue cubes.

For every 16 cubes, 4 would be red and 12 would be blue.

Give reasons for your answers.

False
True
True
False

Introduction to the ratio symbol

Notes and guidance

In this small step, children continue to explore the multiplicative relationship between values, now seeing it written using the ratio symbol, a colon.

Explain that the wording, “For every _____, there are _____” can be written as _____:_____. Show children that the order in which the notation is used is important. For example, for every 2 red cubes there are 3 blue cubes, so red to blue is 2 : 3. For every 3 blue cubes, there are 2 red cubes, so blue to red is 3 : 2. Ensure that children know, and convey in their answers, which number refers to which value.

Children build on the ideas of the previous step to understand that the same ratio can be written in different forms, for example 4 : 6 can be written as 2 : 3. This step is a good opportunity to use contexts such as measure, looking at the ratios of the masses of ingredients in recipes.

Things to look out for

- Children may not understand the meaning of the ratio symbol, and may confuse it with a decimal point.
- When simplifying a ratio, children may try to use additive rather than multiplicative relationships.

Key questions

- If there are 3 blue counters and 5 red counters, how can you describe the relationship between these numbers?
- What does the : symbol mean in the context of ratio?
- What does 2 : 3 mean?
- How can you compare the relationship between three quantities?
- Are the ratios 2 : 3 and 3 : 2 the same?
- How else can you write the ratio 2 : 4?

Possible sentence stems

- For every _____, there are _____, which can be written as _____:_____
- The ratio of _____ to _____ is _____:_____
- In the ratio _____ : _____, the first number represents _____ and the second number represents _____

National Curriculum links

- Solve problems involving the relative sizes of two quantities where missing values can be found by using integer multiplication and division facts

Introduction to the ratio symbol

Key learning

- Complete the sentences.



For every _____ red counters, there are _____ blue counters.

The ratio of red counters to blue counters is _____ : _____

For every _____ blue counters, there are _____ red counters.

The ratio of blue counters to red counters is _____ : _____

- Aisha draws a bar model to show the ratio of yellow to purple gummy bears.

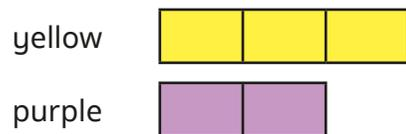

Complete the sentences.

The ratio of yellow gummy bears to purple gummy bears is _____ : _____

The ratio of purple gummy bears to yellow gummy bears is _____ : _____

- Write the ratio of:

- bananas to strawberries
- cherries to strawberries
- strawberries to bananas to cherries
- cherries to strawberries to bananas

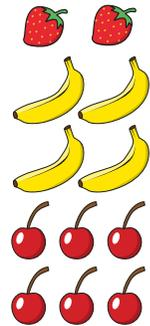

Draw a bar model to represent each ratio.

- Here are 8 red counters.



How many blue counters does he need so that the ratio of red to blue is 4 : 5?

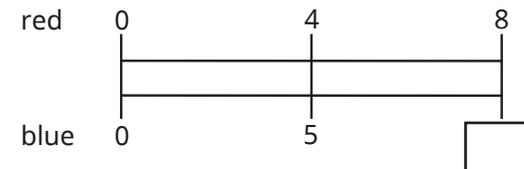

How does the double number line help to work it out?

- Max has blue and red counters in the ratio 3 : 5
He has 15 blue counters.
How many red counters does he have?

Introduction to the ratio symbol

Reasoning and problem solving



Decide if each statement is true or false.

There are 2 yellow tins for every 3 red tins.

There are 2 red tins for every 3 yellow tins.

The ratio of red tins to yellow tins is 2:3

The ratio of yellow tins to red tins is 2:3

Explain your answers.



- True
- False
- False
- True

In a box, there are some red, blue and green pens.

The ratio of red pens to green pens is 3:5



For every 1 red pen, there are 2 blue pens.

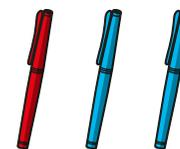

There are 6 red pens in the box.

How many green pens are there?

How many blue pens are there?

Write the ratio of red pens to blue pens to green pens.



10

12

3:6:5

6:12:10

3:6:5

Ratio and fractions

Notes and guidance

In this small step, children explore the differences and similarities between ratios and fractions.

Children may have already noticed that simplifying ratios is similar to simplifying fractions and that both involve dividing by common factors. A possible misconception is thinking, for example, that the ratio 1 : 2 is the same as $\frac{1}{2}$. Exploring links between ratios and fractions using representations such as counters and bar models can help to overcome this. The key point is that a ratio compares one item with another, whereas fractions compare each part with the whole.

Children then explore ratio when given a fraction as a starting point. For example, they are told that $\frac{1}{4}$ of a group of objects is blue, and they need to find the ratio of blue to not blue.

Initially, they may think the ratio is 1 : 4, but concrete resources and diagrams can support them to see it is 1 : 3

Things to look out for

- Children may not consider the whole when linking ratios and fractions. For example, they may think the 2 in 2 : 3 is $\frac{2}{3}$ rather than $\frac{2}{5}$

Key questions

- What is the ratio of one part to another?
- How many parts are there altogether?
- What fraction of the whole is the first/second/third part?
- How are fractions and ratios similar? How are they different?
- What fraction does the ratio 1 : 2 mean? Is this the same as $\frac{1}{2}$ or is it different?
- How can you represent the ratio/fraction as a bar model?

Possible sentence stems

- The ratio of _____ to _____ is _____ : _____
There are _____ parts altogether.
The fraction that is _____ is _____

National Curriculum links

- Solve problems involving the relative sizes of two quantities where missing values can be found by using integer multiplication and division facts
- Solve problems involving unequal sharing and grouping using knowledge of fractions and multiples

Ratio and fractions

Key learning

- The ratio of red counters to blue counters in a box is 1 : 2



- ▶ What fraction of the counters are blue?
- ▶ What fraction of the counters are red?
- ▶ What is the same about the ratio and the fractions?
What is different?

- This bar model represents $\frac{2}{5}$



This bar model represents 2 : 5



What is the same and what is different about the bar models?

- Use the diagram to complete the sentences.



The ratio of blue counters to green counters is 2 : _____

The fraction of counters that are blue is $\frac{2}{\square}$

- One third of the chocolates in a box are mint flavoured.
The rest are strawberry.

Use diagrams to show that the ratio of mint to strawberry chocolates is 1 : 2

- The bar model shows the ratio 2 : 3 : 4



- ▶ What fraction of the bar is pink?
 - ▶ What fraction of the bar is yellow?
 - ▶ What fraction of the bar is blue?
- Esther gets $\frac{2}{5}$ of a packet of 30 sweets.
Huan shares 70 sweets with his friend in the ratio 2 : 5
How many more sweets does Huan get than Esther?
 - Brett opens a box of buttons and counts the different colours.
 - $\frac{1}{2}$ of them are red.
 - $\frac{1}{3}$ them are green.
 - The rest are yellow.

What is the ratio of red : green : yellow buttons in the box?

Ratio and fractions

Reasoning and problem solving

There are some red and green cubes in a bag.

$\frac{2}{7}$ of the cubes are red.

Are the statements true or false?

For every 2 red cubes, there are 7 green cubes.

For every 2 red cubes, there are 5 green cubes.

For every 5 green cubes, there are 2 red cubes.

For every 5 green cubes, there are 7 red cubes.

Explain your answers.



- False
- True
- True
- False

Mrs Fisher plants flowers in a flower bed.

For every 2 red roses, she plants 3 white roses.

$\frac{2}{3}$ of the roses are red.

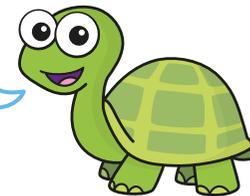

Is Tiny correct?

Explain your answer.



No

Dani makes 240 ml of squash using cordial and water in the ratio 1 : 3

She adds more water to the cup so there is now 300 ml of squash.

What fraction of the drink is cordial?



$\frac{1}{5}$

Scale drawing

Notes and guidance

In this small step, children apply their understanding of ratio and multiplicative relationships through scale diagrams. Before children begin to draw, it is important to spend time exploring what scale diagrams are by getting them to decide by eye if diagrams are accurately scaled or if the proportion of the dimensions has been changed.

Children become familiar with the language of “Each square represents ...” to explain the relationship between the original image and its scale drawing.

Encourage children to explore different ways of calculating scaled lengths using multiplicative relationships between numbers. For example, if 3 cm represents 9 cm, then to find what 6 cm represents they can either multiply 9 cm by 2 or multiply 6 cm by 3 to find the result, 18 cm.

Once children are confident with this and are able to draw squares and rectangles, they may move on to drawing more complex rectilinear shapes.

Things to look out for

- Children may identify the correct scale of enlargement but still become confused by whether they need to multiply or divide.

Key questions

- How do you know if a diagram is drawn to scale?
- Why might you need to draw a scale diagram?
- If 1 square represents 5 cm, what do _____ squares represent? How do you know?
- If 1 square represents 5 cm, how many squares represent _____ cm? How do you know?
- Is there more than one way of finding the missing value?
- How is a scale like a ratio?

Possible sentence stems

- _____ squares represents _____, so each square represents _____
- Each square represents _____, so _____ squares represent _____ \times _____ = _____
- Each square represents _____, so _____ is represented by _____ \div _____ = _____ squares.

National Curriculum links

- Solve problems involving similar shapes where the scale factor is known or can be found

Scale drawing

Key learning

- Here is a picture of a bus.

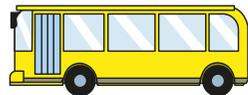

Which two pictures are scale drawings of the original?

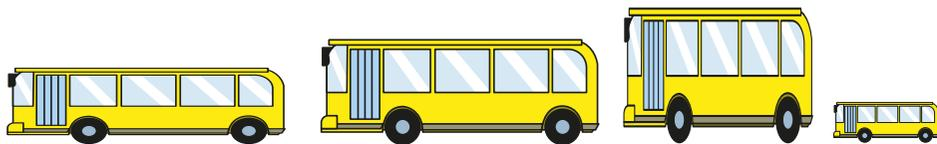

- A square has side lengths of 12 cm.

Scott has drawn a scale diagram of the shape in which the side length of each square in the grid represents 2 cm.

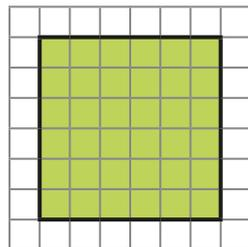

Use squared paper to draw other scale diagrams using the side length of each square to represent:

- 3 cm
- 4 cm
- 6 cm
- 12 cm

- This is a plan of a classroom.

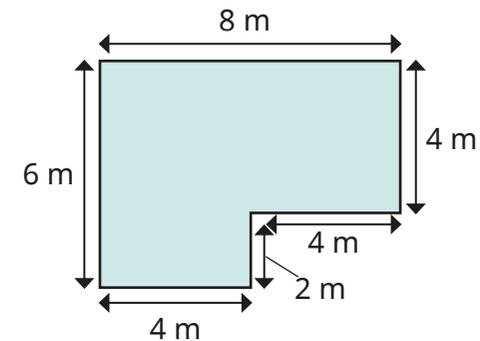

Using squared paper, draw a scale diagram of the classroom if each square on the grid represents 2 m.

- A football pitch measures 48 m by 72 m.
Using squared paper, draw a scale diagram of the football pitch if each square on the grid represents 8 m.
- On a scale diagram, 4 cm represents 1 m.
 - ▶ What does 8 cm represent?
 - ▶ What does 40 cm represent?
 - ▶ What does 2 cm represent?
 - ▶ What does 1 cm represent?
 - ▶ What length in centimetres would represent 3 m?

Scale drawing

Reasoning and problem solving

Tiny wants to draw a scale diagram of this rectangle.

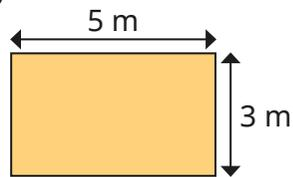

Each square on the grid represents 2 m.

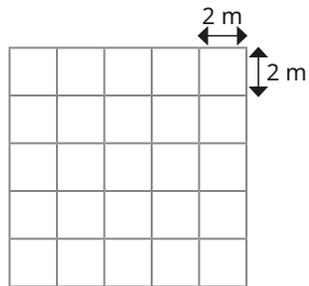

I cannot draw it on this grid, because 3 and 5 are not multiples of 2

Do you agree with Tiny?

Explain your answer.

No

Here is a plan of a room.

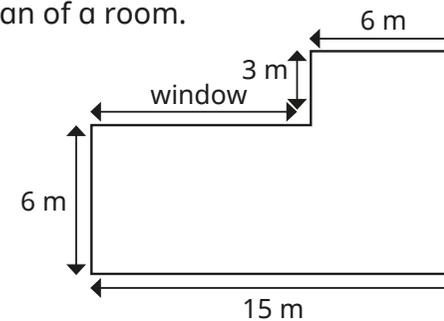

Draw a scale diagram of the room where each square represents 3 m.

What is the actual length of the window?

What is the area, in squares, of the room in the scale diagram?

What is the actual area of the room?

Explain the connection between your answers.

9 m

12 squares

108 m²

Use scale factors

Notes and guidance

In this small step, children build on the previous step to enlarge shapes and describe enlargements.

Children need to know that one shape is an enlargement of another if all the matching sides are in the same ratio. They can use familiar language such as “3 times as big” before being introduced to the language of scale factors, for example “enlarged by a scale factor of 3”. They can then draw the result of an enlargement by a given scale factor. Children also identify the scale factor of an enlargement when presented with both images. Once confident with this, they can explore using inverse operations to find the dimensions of the original shape given the size of the enlargement.

Things to look out for

- Children may not use the scale factor with all the dimensions of the shape.
- Children may use inaccurate measuring when working with shapes with diagonal lines rather than considering the vertical and horizontal distances.

Key questions

- What does “scale factor” mean?
- How do you draw an enlargement of a shape?
- How can you work out the scale factor of enlargement between two shapes?
- If a shape has been enlarged by a scale factor of _____, how can you find the dimensions of the original shape?
- Do you need to multiply or divide to find the missing length? How do you know?

Possible sentence stems

- _____ × _____ = _____
- The shape is _____ times as big, so the scale factor of the enlargement is _____
- If a shape has been enlarged by a scale factor of _____, I need to _____ by _____ to find the original dimensions.

National Curriculum links

- Solve problems involving similar shapes where the scale factor is known or can be found

Use scale factors

Key learning

- Mo draws a square twice as big as square A and labels it B.

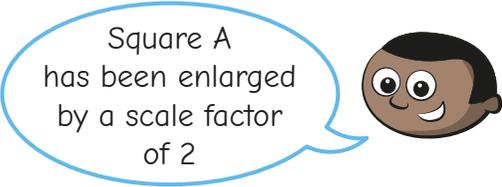
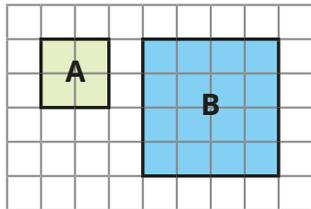

- ▶ Draw a square that is 3 times as big as square A. Label it C.
- ▶ What is the scale factor of enlargement from A to C?

- Use squared paper to complete the enlargements.

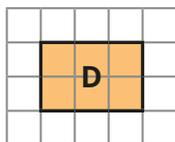

- ▶ Enlarge rectangle D by a scale factor of 2 and label it E.
- ▶ Enlarge rectangle D by a scale factor of 4 and label it F.

- What is the scale factor of enlargement from P to Q?

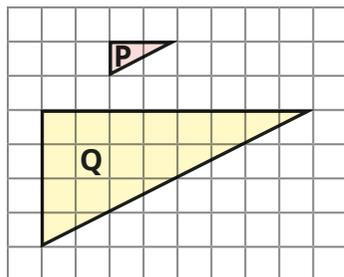

- On squared paper, enlarge the triangle by a scale factor of 3

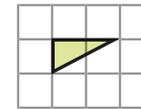

- Here is a quadrilateral.

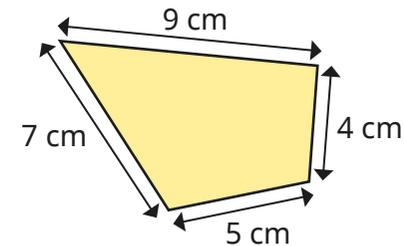

The shape is enlarged by a scale factor of 7

What are the lengths of the sides of the enlarged shape?

- A shape is enlarged by a scale factor of 3
Shape J is the result of the enlargement.

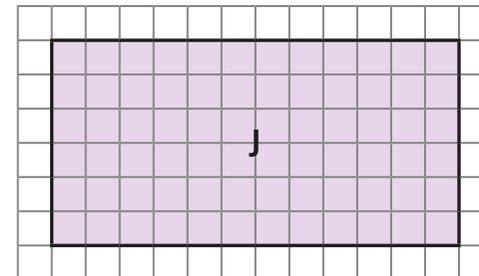

Draw the original shape.

Use scale factors

Reasoning and problem solving

The shape is the result of an enlargement by a scale factor of 4

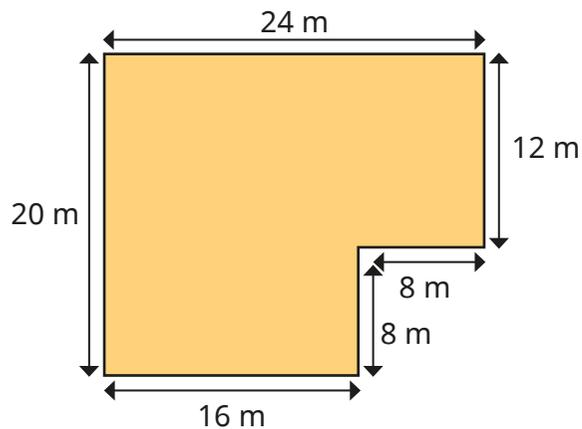

88 m

22 m

What is the perimeter of the enlarged shape?

What is the perimeter of the original shape?

What do you notice?

Kim is enlarging the shape by a scale factor of $1\frac{1}{2}$

I know $\frac{1}{2}$ of 4 is 2,
so $1\frac{1}{2}$ multiplied by 4 is 6
The length of the rectangle is 6

Complete the enlargement.

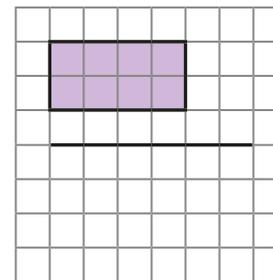

On squared paper, enlarge the shape by a scale factor of $2\frac{1}{2}$

On squared paper, enlarge the shape by a scale factor of $1\frac{1}{4}$

side lengths 6 and 3

side lengths 10 and 5

side lengths 5 and $2\frac{1}{2}$

Similar shapes

Notes and guidance

In this small step, children build on the previous step to explore similar shapes. Similar shapes are defined as shapes where corresponding sides are in the same proportion and the corresponding angles are equal, so if one shape is an enlargement of the other, the two shapes are similar. When testing for similarity, encourage children to work systematically around a shape to ensure that all sides have been enlarged by the same scale factor.

Children can explore the relationship between corresponding angles in the shapes, practising protractor skills learnt in Year 5. Finally, children should apply this understanding to explore similar shapes that are in different orientations, identifying corresponding sides and angles to decide if the shapes are similar.

Things to look out for

- If shapes are in different orientations, children may struggle to identify corresponding sides or just believe the shapes cannot be similar because they do not look the same.
- It is important that children work systematically to ensure all corresponding sides are in the same proportion, rather than just one or two.

Key questions

- What do you think “similar” means?
- What is the scale factor of the enlargement?
- Have all the sides been enlarged by the same amount?
- What are corresponding sides? Can you identify the corresponding sides in these two shapes?
- What do you notice about corresponding angles in similar shapes?
- Does it matter that the shapes are in a different orientation?

Possible sentence stems

- Each side of the shape is _____ times the size, so the shape has been enlarged by a scale factor of _____. Therefore, the shapes are _____
- I know that the shapes are similar, because the corresponding sides have been enlarged by the same _____, and the corresponding angles are _____

National Curriculum links

- Solve problems involving similar shapes where the scale factor is known or can be found

Similar shapes

Key learning

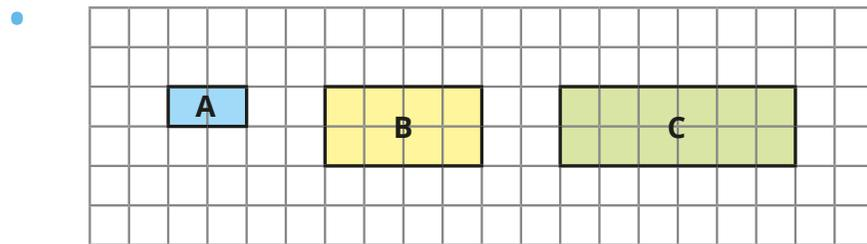

- ▶ Explain why shapes A and B are similar.
- ▶ Explain why shapes A and C are **not** similar.
- ▶ Draw another shape that is similar to A.

Compare answers with a partner.

- Which of the shapes are similar to shape A?

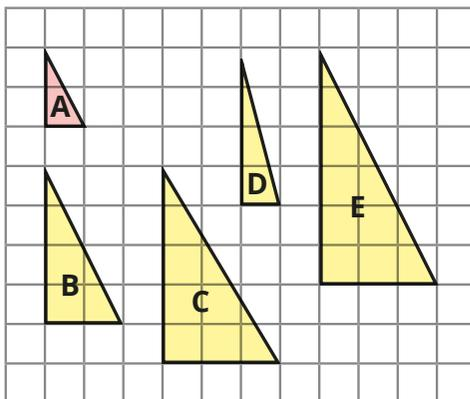

- These two triangles are similar.

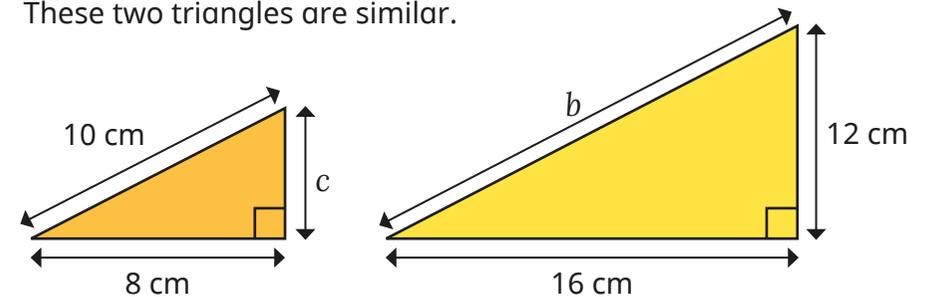

- ▶ Find the lengths of b and c .
- ▶ Measure the sizes of all the angles.
What do you notice?

- These two shapes are similar.

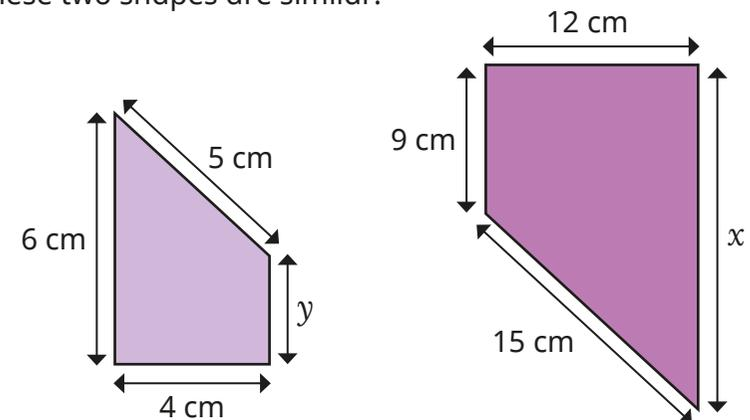

Find the lengths of x and y .

Similar shapes

Reasoning and problem solving

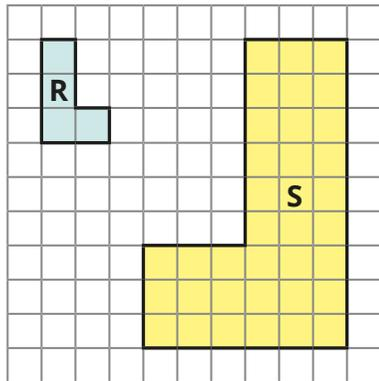

These two shapes cannot be similar, because they are facing different ways.



Do you agree with Tiny?

Explain your answer.

No

The Eiffel Tower is 320 m tall and 120 m wide.

Tommy makes a scale model of the Eiffel Tower.

His model is 16 cm tall.

How wide is his model?

6 cm

Rectangles P and Q are similar.

The perimeter of rectangle P is 14 cm.

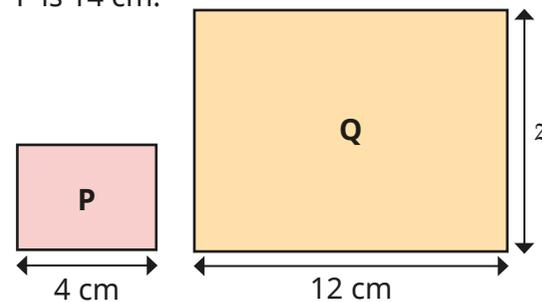

$z = 9$ cm

Work out length z .

Ratio problems

Notes and guidance

In this small step, children use what they have learnt so far in this block to solve a variety of problems involving ratio.

Children use representations from earlier steps to help them see the multiplicative relationships between ratios. They recognise that when they multiply or divide from one amount to another, they do the same for the other value to keep the ratios equivalent. Children may see that this method is similar to finding equivalent fractions. When using double number lines, children can explore the vertical as well as horizontal multiplicative relationships.

Representing problems using bar models supports the interpretation of word ratio problems. These models can be used for a wide range of question types, such as: “If there are _____ blue/red/total, how many blue/red/total are there?” and “If there are _____ more red than blue, how many blue/red/total are there?”

Things to look out for

- Children may confuse the “total” amount for the value of a missing part.
- Children may use additive rather than multiplicative relationships.

Key questions

- What is the ratio of _____ to _____?
- If there are _____, how many _____ must there be?
- If the total number of _____ is _____, how many _____ must there be?
- If there are _____ more _____ than _____, how many are there in total?
- How can you draw a bar model to solve the problem?
Which parts of the model do you know?
How can you work out the remaining parts?

Possible sentence stems

- The ratio of _____ to _____ is _____:_____
- I know that _____ multiplied/divided by _____ is equal to _____, so to find out how many _____ there are, I need to multiply/divide by _____

National Curriculum links

- Solve problems involving the relative sizes of two quantities where missing values can be found by using integer multiplication and division facts

Ratio problems

Key learning

- Ron is doing a sponsored walk for charity.
For every mile he walks, he will raise £7

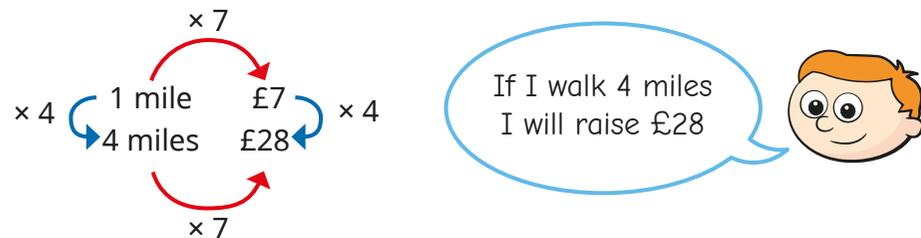

- ▶ How much will Ron raise if he walks 3 miles?
- ▶ How much will Ron raise if he walks 22 miles?
- ▶ How many miles will Ron need to walk to raise £42?

- The double number line shows the relationship between miles and kilometres.
- ▶ Complete the double number line.

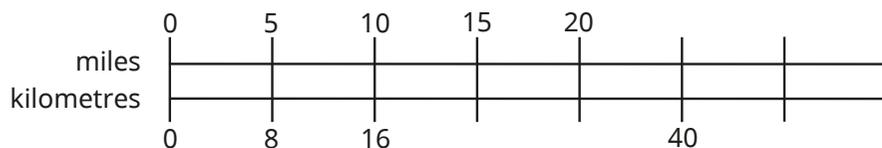

- ▶ Complete the statements.

55 miles = _____ km _____ miles = 96 km

- On a farm, for every 2 cows, there are 5 sheep.

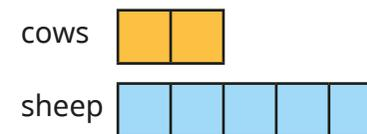

Use bar models to answer the questions.

- ▶ If there are 4 cows, how many animals are there altogether?
 - ▶ If there are 35 animals altogether, how many cows are there?
 - ▶ If there are 50 sheep, how many cows are there?
 - ▶ If there are 12 cows, how many more sheep are there than cows?
- In a car park, there are 4 blue cars for every 7 red cars.
 - ▶ If there are 20 blue cars, how many red cars are there?
 - ▶ If there are 28 red cars, how many blue cars are there?
 - ▶ If there are 22 cars in total, how many of them are blue?
 - ▶ If there are 12 blue cars, how many more red cars are there than blue cars?
 - ▶ If there are 30 more red cars than blue cars, how many cars are there in total?

Ratio problems

Reasoning and problem solving

At a football match, the ratio of home fans to away fans is 7 : 2

Home fans	Away fans
7	2
14	4
21	6
28	8

This means that if there are 200 away fans, there are 700 fans in total.



Do you agree with Tiny?
Explain your answer.

No

The ratio of red to blue to yellow counters is 4 : 3 : 1

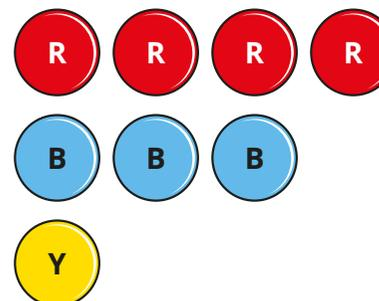

If there are 148 red counters, how many yellow counters are there?

If there are 50 more blue counters than yellow counters, how many red counters are there?

If there are 608 counters in total, how many of them are red?

How did you work this out?

Compare answers with a partner.

37

100

304

Proportion problems

Notes and guidance

In this small step, children explore different strategies for solving proportion problems.

Building on previous steps, a double number line is a useful representation for these types of problems. Begin by looking at simple one-step problems that involve a single multiplication or division, for example “4 _____ cost _____ . What do 12 cost?” or “4 _____ cost _____ . What do 2 cost?”

Then move on to two-step problems, where children first need to find the value of 1 _____ through division. Again, seeing this on a double number line helps to show children that both values need to be divided by the same amount to find 1, then both new values can be multiplied by the same amount to find any new value.

Things to look out for

- In one-step proportion problems, children may multiply by the wrong amount or add instead of multiply.
- When using a double number line in two-step proportion problems, children may count the step to zero and divide by the wrong amount.

Key questions

- What is the multiplicative relationship between _____ and _____ ?
- If 3 _____ cost £ _____ , how much do 12 _____ cost?
- If 5 _____ cost £ _____ , how can you work out what 1 _____ costs?
- Once you know what 1 _____ costs, how can you work out what 8 _____ cost?
- How can a double number line help you solve this proportion problem?

Possible sentence stems

- If _____ costs _____ , then _____ costs _____
- To get from _____ to _____ , I multiply/divide by _____
- To find the cost of 1 _____ , I will ...

National Curriculum links

- Solve problems involving the relative sizes of two quantities where missing values can be found by using integer multiplication and division facts

Proportion problems

Key learning

- 4 pens cost £2.68

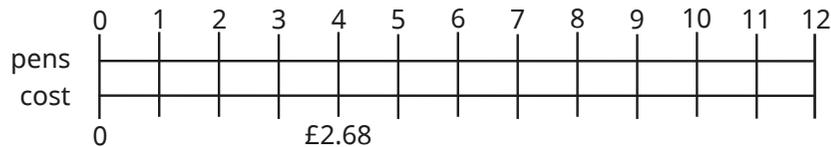

- ▶ Use the double number line to work out the cost of 12 pens.
- ▶ Use a double number line to help you work out the cost of buying:
 - 36 pens
 - 360 pens
- ▶ Use a double number line to help you work out how many pens can be bought for:
 - £1.34
 - £26.80

- Eva buys 3 bread rolls for 75p.

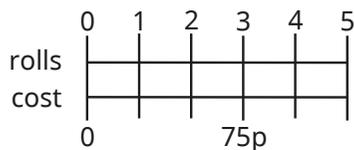

If I know the cost of 3 bread rolls, I can work out the cost of 1 bread roll by dividing by 3

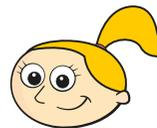

Tell a partner how this will help Eva to find the cost of 5 bread rolls.

What is the cost of 5 bread rolls?

- 3 tables have a total mass of 120 kg.

Dexter and Annie are working out the mass of 9 tables.

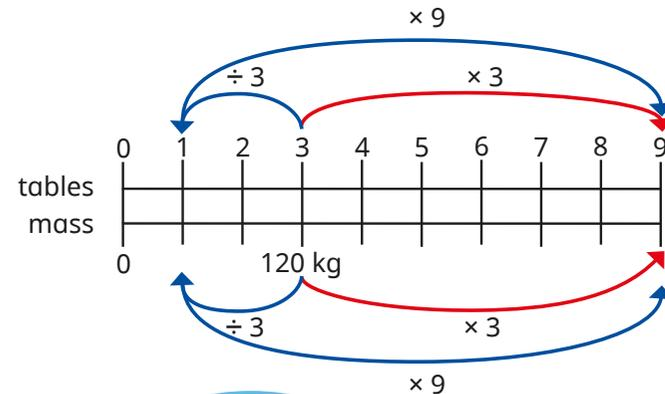

Dexter

I can divide 120 by 3 to find the mass of 1 table and then multiply by 9

I know 3 multiplied by 3 is equal to 9, so I can just multiply 120 by 3



Annie

Use both methods to find the mass of 9 tables.

Whose method do you prefer?

- A shop sells flour at the price of 54p for 0.3 kg.

How much would it cost to buy these masses of flour?

150 g	700 g	2 kg	5.2 kg
-------	-------	------	--------

Proportion problems

Reasoning and problem solving

The cost of 9 chocolate bars is £3.60

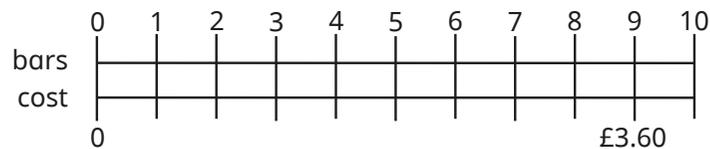

If 9 chocolate bars cost £3.60, then 10 chocolate bars will cost £4.60

Do you agree with Tiny?

Explain your answer.

No

Tiny has added £1, but each chocolate bar does not cost £1

1 chocolate bar costs $£3.60 \div 9 = 40p$

10 chocolate bars cost $40p \times 10 = £4$

It costs a company 12p to make 10 marbles.

Marbles are sold in boxes of 500 for £6.50

How much profit does the company make on every box of marbles?

How did you work it out?

50p

A car travelling at a constant speed travels 24 km in 12 minutes.

How far will the car travel in 1 hour?

How long will it take the car to travel 84 km?

How did you work it out?

120 km

42 minutes

Recipes

Notes and guidance

For this small step, children apply their knowledge of ratio and proportion to solving problems involving ingredients for recipes.

As a class, look at a simple list of ingredients for, for example, 4 people and discuss how it could be adapted for 8/2/40 people. After solving simple scaling-up/scaling-down problems, children look at problems with a given amount of a specific ingredient, for example “The recipe needs 100 g of butter. Aisha has 500 g of butter. How much _____ can she make?”

Children can then explore multi-step problems that involve multiplying and dividing quantities of ingredients, for example adjusting the quantities for 4 people to 5 people by dividing each ingredient by 4 and then multiplying by 5

Things to look out for

- Children may only scale one of the ingredients instead of all of them.
- Children may not see efficient methods for two-step problems.
- Children may make errors when they need to convert between units of measure.

Key questions

- How can a double number line help you decide how much of each ingredient you need?
- How many times more people are there? How will this affect the amount of each ingredient needed?
- Do you need to find the amounts needed for one person first? Why or why not?
- What is the greatest number of _____ you can make with _____?
- How does changing the quantities in a recipe link to using scale factors?

Possible sentence stems

- There are _____ times as many people, so I need _____ times as much of each ingredient.
- First, I will find the quantities for 1 person by dividing by _____ and then I will multiply this by _____

National Curriculum links

- Solve problems involving the relative sizes of two quantities where missing values can be found by using integer multiplication and division facts

Recipes

Key learning

- Here are some ingredients for cupcakes.

Tom wants to make 10 cupcakes.

Explain to a partner how to work out what ingredients Tom will need.

How much of each ingredient will Tom need to make the different numbers of cupcakes?

Cupcakes (makes 5)

100 g flour

2 eggs

40 g sugar

15 cupcakes

20 cupcakes

25 cupcakes

- Here are some ingredients for soup.

How much of each ingredient is needed to make soup for the different numbers of people?

Soup (for 6 people)

1 onion

60 g butter

180 g lentils

1.2 litres stock

480 ml tomato juice

2 people

1 person

9 people

- Sam is making pancakes.

She follows a recipe with this list of ingredients.

She has 1.2 litres of milk and wants to make as many pancakes as she can.

How many eggs will she need?

Pancakes

120 g plain flour

2 eggs

300 ml milk

- Here are the ingredients for an apple crumble.

How much of each ingredient is needed to make apple crumble for the different numbers of people?

Apple crumble (5 people)

300 g plain flour

225 g brown sugar

200 g butter

450 g apples

10 people

12 people

- A baker uses 12 eggs to make 108 muffins.

How many muffins will 20 eggs make?

How many different ways can you work it out?

Recipes

Reasoning and problem solving

Here are the ingredients for 10 flapjacks.



Flapjacks (makes 10)

- 120 g butter
- 100 g brown sugar
- 4 tablespoons golden syrup
- 250 g oats
- 40 g sultanas

Huan has 180 g butter.
 What is the greatest number of flapjacks he can make?
 How much of each of the other ingredients will he need?

15

- 150 g brown sugar
- 6 tablespoons golden syrup
- 375 g oats
- 60 g sultanas

Here are the ingredients for making one smoothie.



Smoothie

- 2 apples
- 3 bananas
- 500 ml milk

I have 7 apples, 9 bananas and 1 litre of milk.

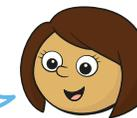

Kim



Alex

I have 6 apples, 10 bananas and 1.5 litres of milk.

I have 10 apples, 5 bananas and 750 ml of milk.



Tommy

Who can make the most smoothies?

Alex

Spring Block 2

Algebra

Small steps

Step 1

1-step function machines

Step 2

2-step function machines

Step 3

Form expressions

Step 4

Substitution

Step 5

Formulae

Step 6

Form equations

Step 7

Solve 1-step equations

Step 8

Solve 2-step equations



Small steps

Step 9

Find pairs of values

Step 10

Solve problems with two unknowns



1-step function machines

Notes and guidance

In this small step, children begin to formally look at algebra for the first time by exploring function machines. This builds on their work in earlier years using operations and their inverses to find missing numbers.

Children need to learn the meanings of the terms “input”, “output”, “function” and “rule”. At first, they are given a number, told what to do to it using any of the four operations and calculate the output. They then move on to finding the input from a given output, using inverse operations.

Finally, children explore examples where the input and output are given, but the function is not. They should recognise that one rule may fit for some of the numbers given, but not for all, and that they need to find a rule that works for all the numbers.

Things to look out for

- Children may carry out the function on the output when working out the missing input, rather than using the inverse operation.
- Children may find a function that works for some of the numbers given, but not all.

Key questions

- How does the function machine work?
- What is the difference between an input and an output?
- If you know the input and function, how can you work out the output?
- If you know the output and function, how can you work out the input?
- What is the inverse of _____?
- Does your rule work for all the sets of numbers?

Possible sentence stems

- If the input is _____, the output is _____
- If I know the output, I need to ...
- If the input is _____ and the output is _____, then the function is _____

National Curriculum links

- Use simple formulae
- Generate and describe linear number sequences

1-step function machines

Key learning

- Mo has made a function machine.

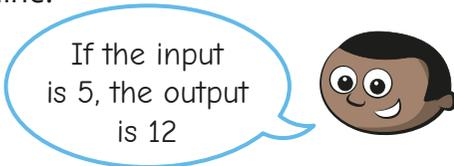
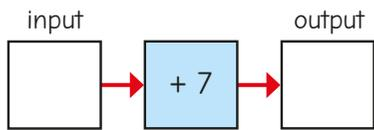

- ▶ If the input is 7, what is the output?
- ▶ If the input is 4,023, what is the output?

- Complete the table for the function machine.

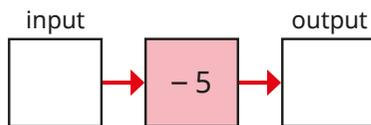

Input	5	23	5.1	23.2	0	-3	-5
Output							

- Complete the table for the function machine.

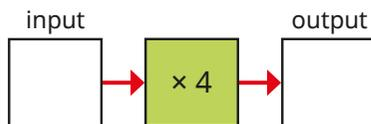

Input	3	10	0	2.5	0.25	7	70
Output							

- The function machine shows the output, but not the input.

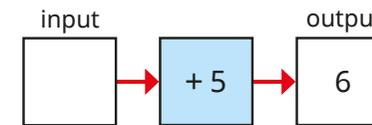

Talk to a partner about how you can work out the input.

- Work out the missing inputs.

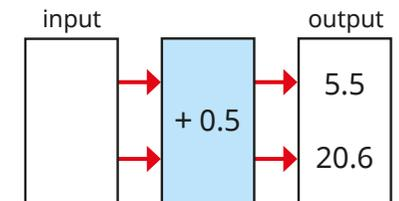
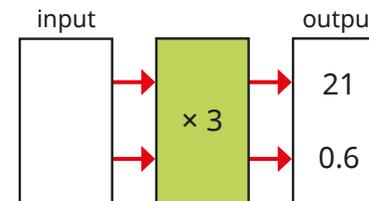

- What are the missing functions?

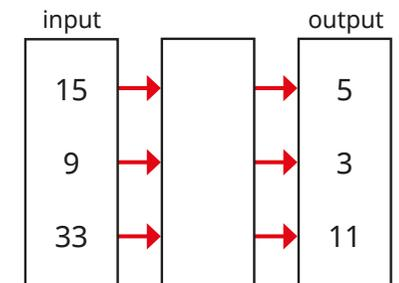
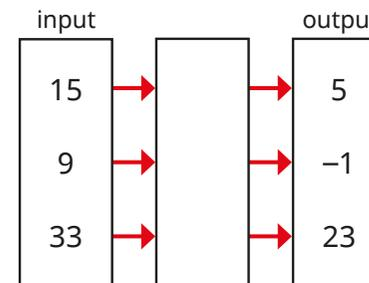

What do you notice?

1-step function machines

Reasoning and problem solving

Jo and Ron are working out the rule for the function machine.

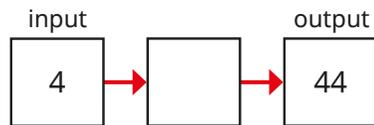

Jo

The rule is
 $+ 40$

The rule is
 $\times 11$



Ron

Who do you agree with?
Explain your answer.

Either could be correct.

Tiny is working out the missing number.

Input	9	7	3.5	-2
Output	19	17	13.5	

The missing number is -12

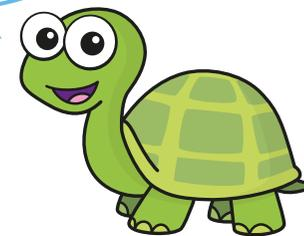

Explain Tiny's mistake.
What is the missing number?

8

2-step function machines

Notes and guidance

In this small step, children move on to explore function machines with two steps.

As with 1-step machines, they start by looking at examples where the input is given and they need to find the output, using a mix of any of the four operations. Discuss why it is important that they follow the order of the functions; for example, the output of $\times 5$ then $+ 3$ will be different from $+ 3$ then $\times 5$

Children then move on to finding the input when the output is known by using the inverse of each function, recognising that they need to start with the second function when working backwards.

Children then look at problems where the input and output are given, but one of the two functions is missing. They may choose to do this problem working forwards or backwards.

Things to look out for

- Children may not follow the order of the functions, and it is important to explore the effect this can have.
- When finding the input, children may do the inverse of the first function first.

Key questions

- Which function should you apply first?
- What happens if you do not follow the functions in the correct order?
- What is the inverse of _____?
- When given the output, which function should you do first?
- What is the input if the output is _____?
- What is the missing function if the input is _____, the output is _____ and one of the functions is _____?
- Does it always matter what order you apply the functions?

Possible sentence stems

- First, I am going to _____, then I am going to _____
- If the input is _____, then the output is _____
- The inverse of _____ then _____ is _____ then _____

National Curriculum links

- Use simple formulae
- Find pairs of numbers that satisfy an equation with two unknowns
- Enumerate possibilities of combinations of two variables

2-step function machines

Key learning

- Here is a 2-step function machine.

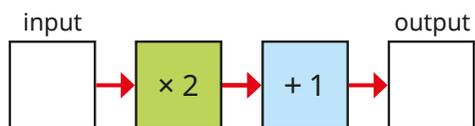

- ▶ If the input is 5, what is the output?
- ▶ If the input is 10, what is the output?

- Complete the tables for the function machines.

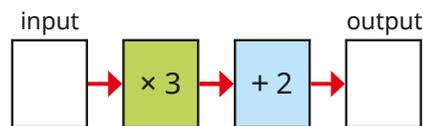
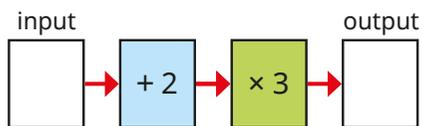

Input	3	4	5	10
Output				

Input	3	4	5	10
Output				

What do you notice?



I think of a number, double it, then add 4

- ▶ What answer will Max get if he thinks of 20?
- ▶ What number would Max need to think of to get the answer 20?

- Work out the missing inputs.

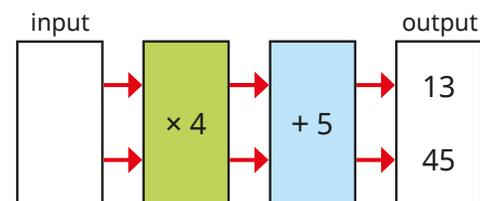
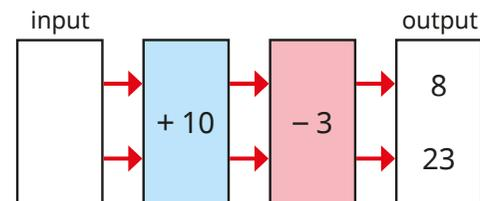

- What are the missing functions?

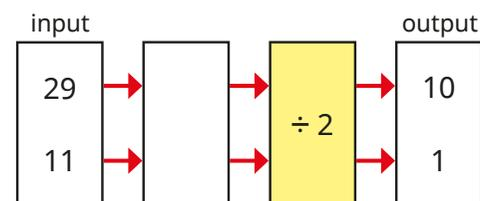
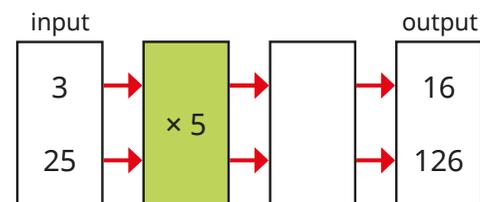

2-step function machines

Reasoning and problem solving

Tiny is using a 2-step function machine.

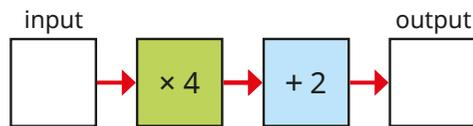

You can multiply numbers in any order, and you can add numbers in any order. This means you can solve this function machine in any order.



Do you agree with Tiny?
Explain your answer.



No

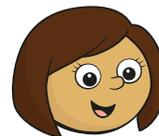
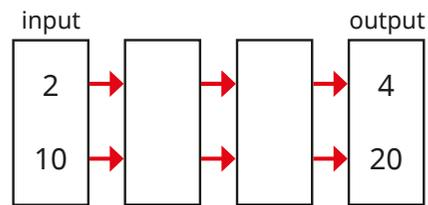

Kim

The missing functions are $\times 4$ and $\div 2$

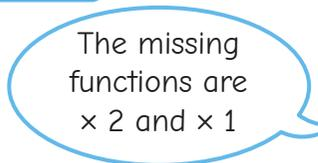

Teddy

The missing functions are $\times 2$ and $\times 1$



Whitney

There only needs to be one function, which is $\times 2$

Who do you agree with?

What other functions would work?



They are all correct.

Form expressions

Notes and guidance

This small step is children's first experience of forming algebraic expressions using letters to represent numbers.

Children learn that phrases such as "2 more than a number" can be written more simply as, for example, " $x + 2$ " or " $y + 2$ ". They also learn the convention that, for example, " $3t$ " means 3 multiplied by t ; as multiplication can represent repeated addition, this is also a simpler way of writing $t + t + t$. They use cubes and base 10 ones to represent expressions, with each cube representing an unknown number, x (or any letter), and the ones representing known numbers.

Children then revisit function machines, where x (or any letter) can represent the input. Discuss why it is not important at this stage to know what x represents, and that it could be any number input into the function machine.

Bar models can also be used to support children's understanding.

Things to look out for

- Children may assume that certain letters always represent specific numbers, for example a means 1, b means 2, c means 3 and so on.
- Children may not see $a \times 3$ and $3a$ as the same thing.

Key questions

- What could x represent?
- How can you represent this expression using a bar model?
- How else can you write $a + a$?
- What is the same and what is different about the expressions $x + 5$ and $5x$?
- If the input is p , what is the output?
- If m is the input, what is the output after the first operation? What is the output after the second operation?

Possible sentence stems

- _____ more than x can be written as _____
- _____ + _____ + _____ = $3 \times$ _____ = _____
- If I have _____ x and I add/subtract _____ x , then I have _____ x altogether.

National Curriculum links

- Use simple formulae
- Express missing number problems algebraically

Form expressions

Key learning

- Jo and Max are using cubes to represent unknown numbers and base 10 ones to represent 1

= x = 1

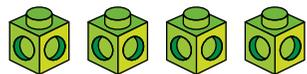

I have 4 lots of x , which I can write as $4x$.

Jo



Max

I have $3x$ and 2. This is $3x + 2$



Use Jo and Max's method to write algebraic expressions for each set of cubes and base 10 ones.

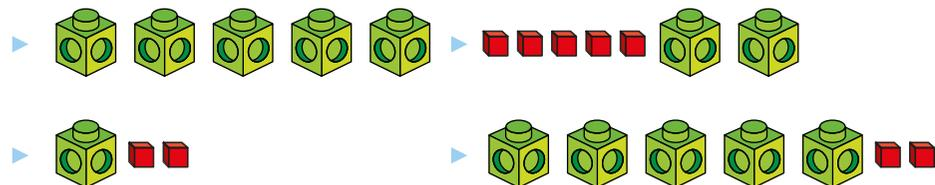

- Use cubes and base 10 to represent the algebraic expressions.

$y + 3$

$2y + 1$

$5 + 5y$

- Dan writes an expression for the 2-step function machine.

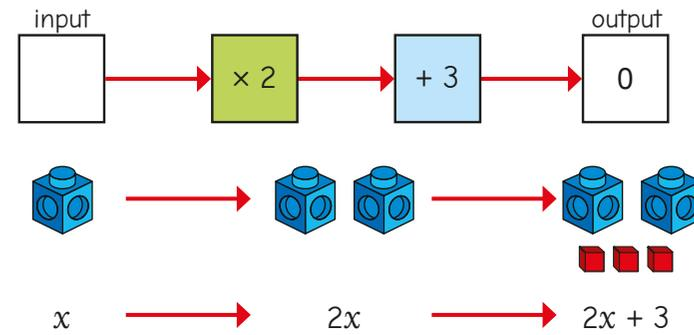

Use Dan's method to write an expression for each function machine.

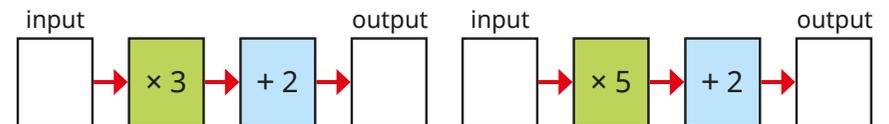

- I think of a number, double it, then add 7

Sam calls the number she first thinks of x .

Write an expression for the number that Sam is thinking of after she has done the two calculations.

Form expressions

Reasoning and problem solving

Write expressions for the perimeters of the shapes.

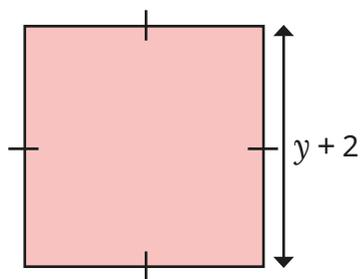
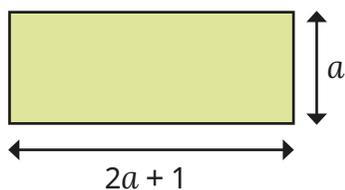
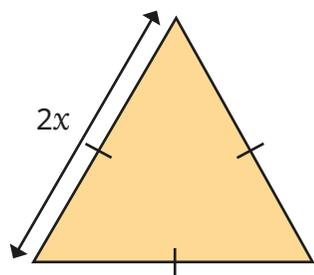

$6x$

$6a + 2$

$4y + 8$

The perimeter of a rectangle is $12x$.

What could the sides of the rectangle be?

multiple possible answers, e.g. $5x$ and x

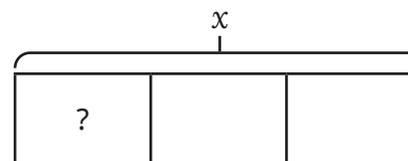

The bar model represents $3x$ because x is the total and there are three parts.

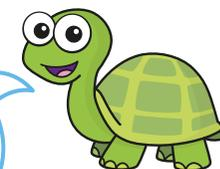

No
Each part is $x \div 3$

Do you agree with Tiny?

Explain your answer.

Substitution

Notes and guidance

In this small step, children find values of expressions by substituting numbers in place of the letters.

Children should understand that the same expression can have different values depending on what number is substituted into it. Before working with letters, children explore concrete and pictorial representations. By assigning values to, for example, a square and a triangle, they can work out square + triangle. Similarly, building on representations from the previous step, if they assign a value to a cube, they can work out the value of an expression.

Children then move on to substituting numbers into abstract algebraic expressions such as $3a + 1$. This can be linked to the earlier learning of function machines, and thought of as “multiply by 3 and then add 1”, or bar models, replacing each occurrence of the letter with its value.

Things to look out for

- Children may think that a is always equal to 1, b always equal to 2 and so on.
- If $a = 3$, children may see $2a$ as 23 rather than $2 \times 3 = 6$
- Children may misinterpret expressions such as $2a + 3$ as $5a$.

Key questions

- If 1 cube is worth _____, what are 3 cubes worth?
- What does $4x$ mean? If you know the value of x , how can you work out the value of $4x$?
- What does “substitute” mean?
- How can you represent the expression as a bar model? Which parts of the bar model can you replace with a number? What is the total value of the bar model?
- Which part of the expression can you work out first? What is the total value of the expression?

Possible sentence stems

- If _____ is worth _____, then _____ is worth _____
- To work out the value of _____, I need to replace the letter _____ with the number _____ and then calculate _____

National Curriculum links

- Use simple formulae
- Express missing number problems algebraically

Substitution

Key learning

- Ann gives values to these cubes.



Work out the values of the sets of cubes.

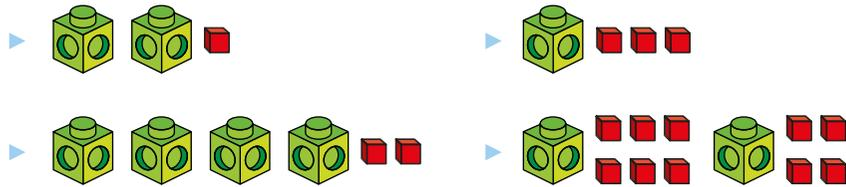

- Tom draws three shapes and gives each one a value.

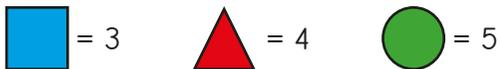

Work out the values of the expressions.



- Here are three expressions.

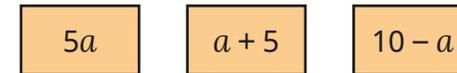

- ▶ Which expression has the greatest value when $a = 1$?
 - ▶ Which expression has the greatest value when $a = 5$?
 - ▶ Which expression has the greatest value when $a = 10$?
- Esther generates a sequence by substituting $n = 1, n = 2, n = 3, n = 4$ and $n = 5$ into the expression $4n + 1$

When $n = 1,$
 $4n + 1 = 4 \times 1 + 1 = 4 + 1 = 5$

Work out the other numbers in Esther's sequence.

What patterns can you see?

- If $a = 5$ and $b = 12,$ work out the values of the expressions.



Substitution

Reasoning and problem solving

$$x = 2c + 6$$



Mo

$x = 12$, because c must be equal to 3 as it is the 3rd letter in the alphabet.

Is Mo correct?

Explain why.

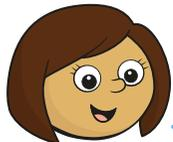

Kim

When $c = 5$,
 $x = 31$

Explain why Kim is wrong.

What is the correct value of x when $c = 5$?

No

Kim has put the 2 next to the 5 to make 25, instead of multiplying 2 by 5

$x = 16$

Work out the missing values in the table.

x	$3x$	$3x + 5$
1		
3		
	12	
	36	
		20
		26

row 1: 3, 8

row 2: 9, 14

row 3: 4, 17

row 4: 12, 41

row 5: 5, 15

row 6: 7, 21

Find the value of c when $a = 10$

$$p = 2a + 5$$

$$c = 10 - p$$

$c = -15$

Formulae

Notes and guidance

In this small step, children are introduced to formulae using symbols for the first time, although they will be familiar with the idea of a formula in words, for example area of a rectangle = length \times width.

Building on the previous steps, children substitute into formulae to work out values, noticing the effect that changing the input has on the output. Looking at familiar relationships between two or more variables will help to develop children's understanding, for example the number of days in a given number of weeks, the number of legs on a given number of insects and so on.

Children should recognise the difference between a formula and an expression, noticing that an expression does not have the equals sign, but a formula does.

Things to look out for

- Children may mix up the variables in a formula, for example using $w = 7d$ to represent the formula for the number of days in a given number of weeks.

Key questions

- What is a formula?
- What formulae do you know?
- How is a formula similar to/different from an expression?
- What is the formula for _____?
- If the formula is $t = 3s + 1$ and you know that $s = \text{_____}$, how can you work out t ?
- Which letter(s) do you know the value of? Which letter(s) can you work out?

Possible sentence stems

- In the formula _____, the letter _____ represents _____ and the letter _____ represents _____
- To work out _____ when I know _____, I substitute _____ into the formula.

National Curriculum links

- Use simple formulae
- Express missing number problems algebraically

Formulae

Key learning

- Ron uses a formula to work out the areas of rectangles.

$$A = lw$$

When $l = 7$ and $w = 4$, $A = 7 \times 4 = 28$

- ▶ What do the letters A , l and w represent?
- ▶ Use the formula to find the areas of the rectangles.

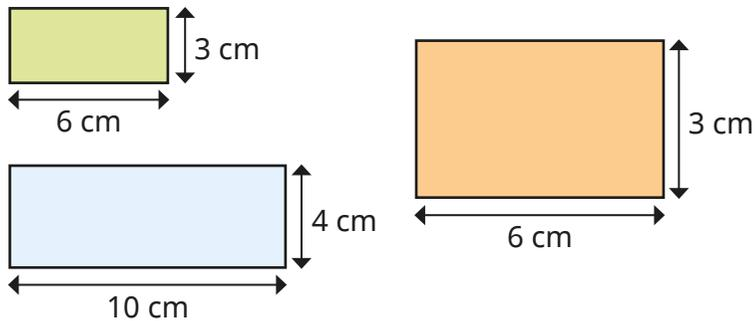

- The time taken to cook a turkey is 90 minutes, plus an additional 20 minutes for every kilogram of turkey.

This can be written as the formula $T = 90 + 20m$

- ▶ What do the letters T and m represent?
- ▶ Use the formula to work out the time to cook:
 - a 3 kg turkey
 - a 10 kg turkey

- Fay makes a sequence of patterns with stars and circles.



Complete the table to show the number of circles and stars in the patterns.

Number of stars	1	2	3	5		
Number of circles	2				18	30

If s = number of stars and c = number of circles, which formula describes Fay's pattern?

- $s = 2 + c$
- $c = s + 2$
- $c = 2s$
- $s = 2c$
- $2s = c + 2$

- The table shows the total number of legs on a given number of ants.

Number of ants (a)	1	2	3		
Number of legs (L)	6			30	72

Complete the table and write a formula that describes the pattern.

Formulae

Reasoning and problem solving



S = number of spiders
 L = total number of legs

I think that the formula for working out the total number of legs for a number of spiders is $S = 8L$.

Do you agree with Sam?
Explain your answer.

No

Max and Jo use this formula to work out the cost in pounds (C) of four hours (h) of cleaning.

$$C = 20 + 10h$$

I think it is £120

Max

I think it is £60

Jo

Who do you agree with?
Explain your answer.

Jo

Form equations

Notes and guidance

In this small step, children form equations from diagrams and word descriptions.

Begin the step by looking at the difference between an algebraic expression and an equation. An expression, such as $2x + 6$, changes value depending on the value of x , whereas in an equation, such as $2x + 6 = 14$, x has a specific value. You may need to remind children of the algebraic conventions learnt earlier in the block, for example writing $a + a + a$ (or $a \times 3$) as $3a$ and “4 more than b ” as $b + 4$.

Various representations can be used to support children’s understanding, including bar models, part-whole models and cubes and counters with a designated value. It is important that children understand that, for example, the letter c represents the numerical value of the cube rather than the cube itself.

Things to look out for

- Children may look to work out the value rather than represent the information as an equation.
- Children may make errors using algebraic notation, for example confusing $3x$ and $x + 3$

Key questions

- If a is a number, how do you write “3 times the value of a ”?
- How do you write “4 more than the number x ”?
- If 4 more than the number x is equal to 26, how can you write this as an equation?
- Is an equation the same as or different from a formula?
- What is the difference between an equation and an expression?
- Can you write the equation a different way?
- Is _____ an equation or an expression? How do you know?

Possible sentence stems

- _____ + _____ + _____ = $3 \times$ _____ = _____
- The equation _____ means that the expression _____ is equal to _____
- _____ more/less than _____ is equal to _____ can be written as the equation _____ = _____

National Curriculum links

- Express missing number problems algebraically

Form equations

Key learning

- Tom thinks of a number and calls it x .

Which expression represents 5 more than Tom's number?

$5x$	$x + 5$	$x - 5$	$x \div 5$
------	---------	---------	------------

Double Tom's number is 64

Which equation shows this information?

$x + 2 = 64$	$x \div 2 = 64$	$2x = 64$	$x - 2 = 64$
--------------	-----------------	-----------	--------------

- Max has represented some equations.

Each linking cube represents y and each base 10 cube represents 1

$2y + 3 = 7$

What equations are represented?

- Write equations to match the models.

9		
x	x	x

11		
a	a	5

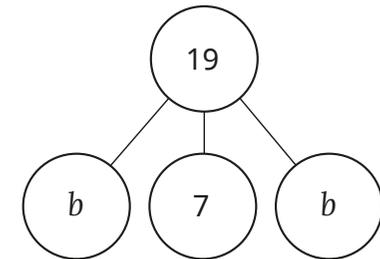
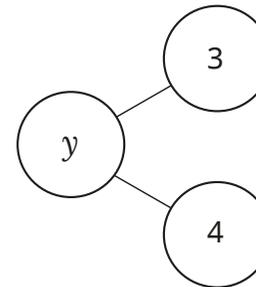

- A book costs £5 and a magazine costs $\pounds n$.

The total cost of the book and the magazine is £8

Write this information as an equation.

- Write algebraic equations for the word problems.

▶ I think of a number and subtract 17. My answer is 20

▶ I think of a number and multiply it by 5. My answer is 45

- Draw bar models to represent the equations.

$x + 5 = 11$

$2y = 15$

$3a + 9 = 30$

Form equations

Reasoning and problem solving

Here is a part-whole model.

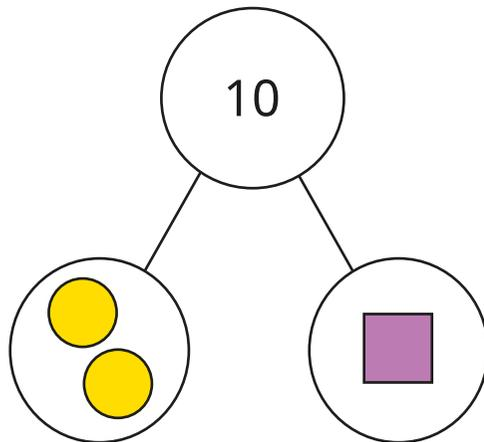

Write an equation representing the part-whole model.

Each shape has a different integer value.

What values might the shapes have?

Using c for circles and s for squares:

$$2c + s = 10$$

multiple possible answers, e.g.

$$c = 2, s = 6$$

Kim is thinking of a number.

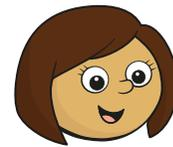

If I multiply my number by 3 and then subtract 12, I get the answer 24

I can write that as an equation.

$$x - 12 \times 3 = 24$$

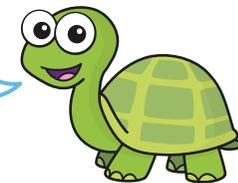

What mistake has Tiny made?

Write the correct equation for Kim's problem.

Tiny has not applied the operations in the correct order.

$$3x - 12 = 24$$

Solve 1-step equations

Notes and guidance

In this small step, children look at solving equations formally for the first time. At first, they might find the notation a bit confusing, but encourage them to consider equations as a different way of writing “missing number” problems.

For example, $x + 5 = 12$ is the same as $\text{_____} + 5 = 12$

It is useful to begin by looking at “think of a number” questions, such as “Mo thinks of a number, adds 7 and gets the answer 20. What was his original number?” and relating this to the equation $n + 7 = 20$. Similarly, you can build on earlier learning using function machines, relating finding an input for a given output to solving the corresponding equation. In both cases, children should see that using inverse operations helps to solve the equations.

Things to look out for

- Children may not use the inverse operation to solve an equation, for example $x + 3 = 5$, so $x = 8$
- Children may think that the values of letters are permanently fixed. For example, having solved an equation for x , they may apply this value for x to a different equation.

Key questions

- What does the expression $3x$ mean?
- If you know 3 times the value of a number, how can you use this to work out the number?
- How can you represent the problem as a bar model?
- How can you represent the problem as an equation?
- What is the inverse of _____?
- What does the bar model show?
What can you use it to work out?
- How can you draw a function machine to represent the equation?
How does the function machine help you to solve the equation?

Possible sentence stems

- The inverse of _____ is _____
- If _____ has been added to a number to give _____, then to work out the number I need to _____ from _____

National Curriculum links

- Express missing number problems algebraically

Solve 1-step equations

Key learning

- Ben has 9 counters altogether.

He has 3 counters in his left hand and c counters in his closed right hand.

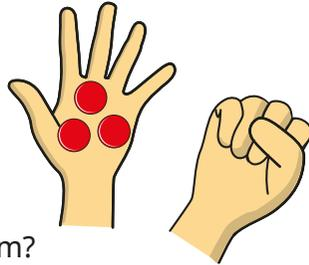

Which equation represents this problem?

$c - 3 = 9$
 $3c = 9$
 $c + 3 = 9$
 $c = 9 + 3$

How many counters does he have in his closed hand?

- Fay thinks of a number.

She adds 9 to her number.

She gets the answer 15

What was her original number?

Explain how the equation $x + 9 = 15$ represents this problem.

- Dan thinks of a number and multiplies it by 3 to get the answer 12

Which equation shows this?

$3x = 12$
 $3 + x = 12$
 $x - 3 = 12$
 $x \div 3 = 12$

What was Dan's original number?

- Write expressions for the outputs of the function machines.

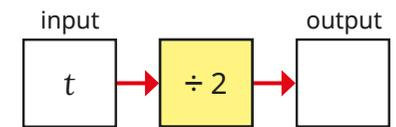
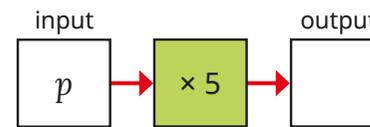
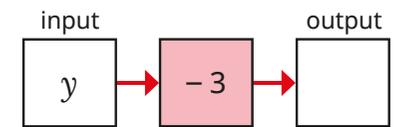
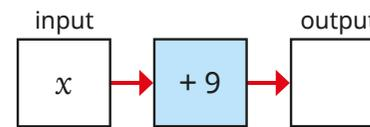

If the output of all the machines is 20, write and solve equations to find the values of the letters.

- Write an equation to represent each bar model.

Then find the value of x for each one.

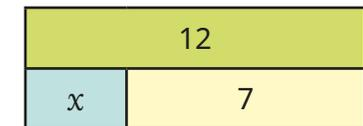
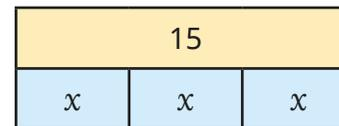

- Solve the equations.

$3x = 21$
 $y + 5 = 11$
 $z - 6 = 8$
 $p \div 3 = 10$

Solve 1-step equations

Reasoning and problem solving

The perimeter of the triangle is 216 cm.

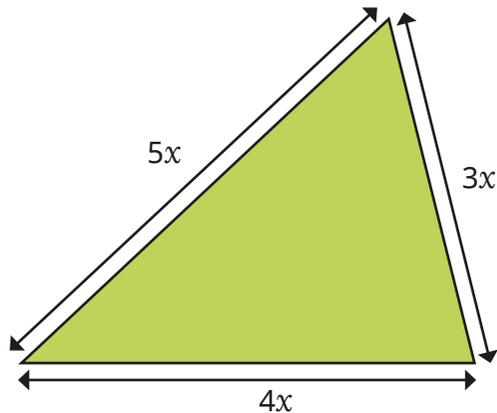

Form an equation to find the value of x .

Work out the lengths of the sides of the triangle.

$$12x = 216$$

$$x = 18$$

54 cm, 72 cm and 90 cm

$$x - 9 = 0$$

This means that x must equal zero.

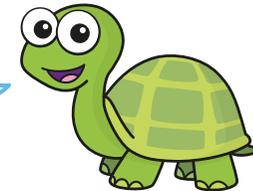

Do you agree with Tiny?
Explain your answer.

No

Work out the size of the acute angle.

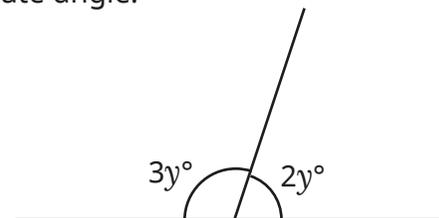

How can you check your answer?

72°

Solve 2-step equations

Notes and guidance

In this small step, children move on to solving equations with two steps.

As with 1-step equations, initially equations of this type can be represented by 2-step “think of a number” problems and/or function machines, where children work backwards using inverse operations to find the original number or input. They can then link this to finding an unknown in a 2-step equation.

Children can also use concrete resources to represent the problems and to work out missing numbers. Bar models are another useful representation, as they give a visual clue to the steps needed to work out the unknowns. It is useful to have the abstract representation alongside the models to help develop understanding.

Things to look out for

- Children may think the values of letters are permanently fixed. For example, having solved an equation for x , they may apply this value for x to a different equation.
- When “working backwards” to solve equations, children may do the inverse operations in the wrong order.

Key questions

- If you know 3 more than $2x$, how can you work out $2x$?
- If you know 5 less than $2x$, how can you work out $2x$?
- How can you represent the problem with a bar model? Which part(s) of the bar model do you already know? Which part(s) can you work out?
- How can you represent the problem with an equation? What is the first step you need to take to solve the equation?
- How can you represent the equation using a function machine? How can you use the function machine to help you solve the equation?

Possible sentence stems

- If _____ x + _____ = _____, then _____ x = _____, so x = _____
- The first step in solving the equation is to _____
The second step in solving the equation is to _____

National Curriculum links

- Express missing number problems algebraically

Solve 2-step equations

Key learning

- Tommy has 17 counters.

He puts the same number of counters (c) in each hand and has some left over.

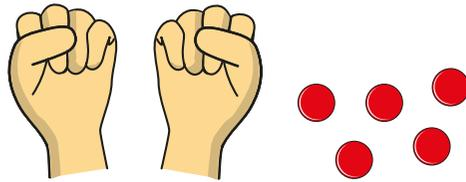

Which equation shows this?

$c + 2 = 5$	$2c = 17$	$2c + 5 = 17$	$2c + 17 = 5$
-------------	-----------	---------------	---------------

Solve the equation to work out how many counters Tommy has in each hand.

- Kay thinks of a number.

She multiplies the number by 2 and then adds 5

She gets the answer 29

What number did Kay think of?

- Explain how this 2-step function machine shows the equation

$$2x - 11 = 29$$



Work out the value of x .

- Ron uses a bar model to solve an equation.

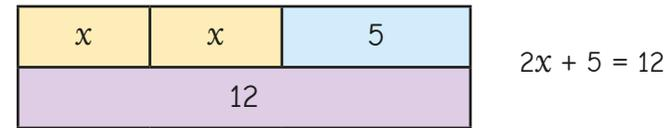

Use Ron's method to solve the equations.

$3b + 4 = 19$	$20 = 4b + 2$
---------------	---------------

- Write and solve equations for the models.

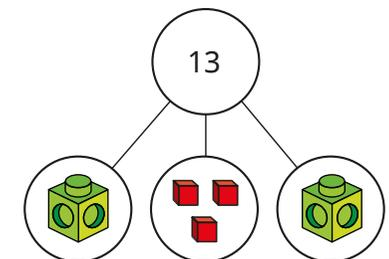
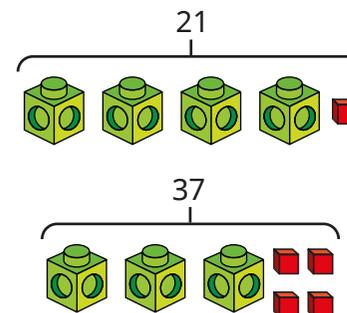

Solve 2-step equations

Reasoning and problem solving

Tiny is working out the value of x .

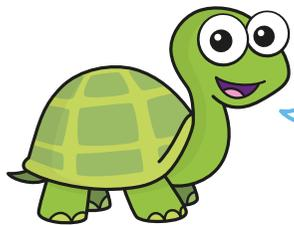
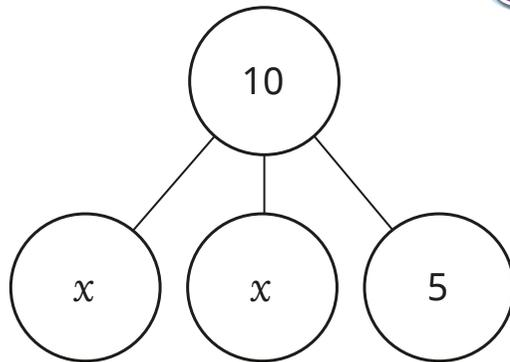

$10 - 5 = 5$,
so $x = 5$

Do you agree with Tiny?
Explain your reasoning.



No

The perimeter of the quadrilateral is 83 cm.

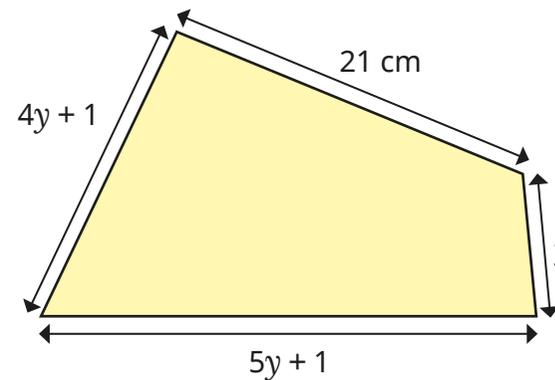

$y = 6$ cm

Work out the value of y .
Explain your method to a partner.



Find pairs of values

Notes and guidance

In this small step, children explore equations with two unknown values, recognising that these can have several possible solutions.

Children can use substitution to work out pairs of possible values. For example, if $x + y = 9$, they find the values of y for different values of x . They should work systematically to find all the possible integer values. A table is a good way to support this. In this step, the possible values will always be integers greater than or equal to zero, but this could be extended to negative and decimal values. Begin with simple equations of the form $x + y = \text{_____}$ or $ab = \text{_____}$, before moving on to more complex equations that include multiples of the unknowns, for example $2x + 3y = \text{_____}$

It is important that children understand that they cannot know the exact value of the two unknowns, as they do not have enough information.

Things to look out for

- Children may not consider zero as a possible value for one of the unknowns.
- Children may need support to work systematically to find all possible solutions.

Key questions

- What two numbers could add together to make _____?
- What could the values of x and y be in the equation _____?
- Why are there several possible answers for this question?
- Have you found all the possible pairs of values?
How do you know?
- In the equation _____, if $x = \text{_____}$, what must the value of y be? If x is a different value, does y also change?
- How can you draw a bar model to represent the equation _____?

Possible sentence stems

- In the equation $x + y = \text{_____}$, if $x = \text{_____}$ then $y = \text{_____}$
- If the product of p and q is _____, then p could be _____ and q could be _____

National Curriculum links

- Find pairs of numbers that satisfy an equation with two unknowns
- Enumerate possibilities of combinations of two variables

Find pairs of values

Key learning

- x and y are both whole numbers.

$$x + y = 5$$

Ann creates a table to work out the possible sets of values of x and y .

x	y	$x + y$
0	5	5
		5
		5
		5
		5
		5

Work systematically to complete Ann's table.

- a and b are both whole numbers.

$$a \times b = 24$$

Create a table to show all the possible sets of values for a and b .

- p and q are both whole numbers less than 12

$$p - q = 3$$

Find all the possible values of p and q .

- x and y are both whole numbers.

$$x > y$$

$$x + y = 25$$

- ▶ If x is odd and y is even, what are the possible pairs of values for x and y ?
- ▶ If x and y are both even, what are the possible pairs of values for x and y ?
- ▶ If x is a multiple of 5 and y is even, what are the possible pairs of values for x and y ?

Create your own problem like this for a partner.

- a and b are integers.

$$3a + 2b = 20$$

Work out three possible pairs of values for a and b .

Compare methods with a partner.

Find pairs of values

Reasoning and problem solving

a and b are both whole numbers.

$ab + b = 18$

a and b must both be odd numbers.



Is Tiny correct?
Explain your answer.

No

a , b and c are integers between 0 and 5

$a + b = 6$

$b + c = 4$

Find the values of a , b and c .
How many possibilities can you find?

- $a = 2, b = 4, c = 0$
- $a = 3, b = 3, c = 1$
- $a = 4, b = 2, c = 2$
- $a = 5, b = 1, c = 3$

Large beads costs 5p and small beads cost 4p.

Sam spends 79p on beads.

What possible combinations of large beads (l) and small beads (s) could she buy?

Write each possible combination as an expression.

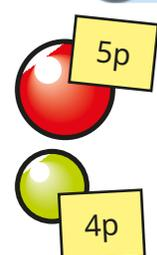

- $3l + 16s$
- $7l + 11s$
- $11l + 6s$
- $15l + s$

Solve problems with two unknowns

Notes and guidance

Building on previous learning, in this small step children solve problems with two unknowns when more than one piece of information is given, so there is only one possible solution.

Examples include the case where the sum and the difference of both unknowns is given. Bar models are used throughout the step to represent problems and to support children's understanding.

Other structures are also explored, including where one of the unknowns is a multiple of the other. In this case, a bar model can be used to work out the values of the numbers if either their total or their difference is known. Finally, children look at equations with two unknowns where the coefficient of only one of the unknowns is different, for example $x + 2y = 17$ and $x + 5y = 38$. Again, a bar model will help children to see why $3y$ must be equal to 21, after which y and x can be found.

Things to look out for

- Children may use trial and error rather than a bar model approach.
- Children may think that there are several possible solutions, as in the last step.

Key questions

- How can you represent this information as a pair of equations?
- How can you represent this information with a bar model?
- What information does the bar model show?
What else can you work out?
- How can you draw a bar model to represent the problem?
Which parts can you label straight away?
What else can you work out?
- Is there more than one possible solution?

Possible sentence stems

- If _____ lots of x is worth _____, then
 $x = \text{_____} \div \text{_____} = \text{_____}$
- If I know the value of _____, I can find the value of _____ by substituting into the equation _____

National Curriculum links

- Express missing number problems algebraically
- Find pairs of numbers that satisfy an equation with two unknowns

Solve problems with two unknowns

Key learning

- The sum of a and b is 30

The difference between a and b is 4

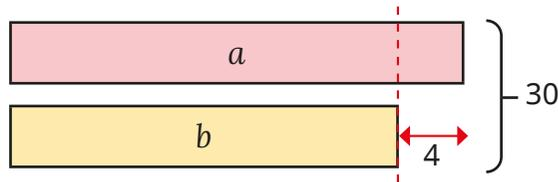

Use the bar model to work out the values of a and b .

- Here is some information about two numbers, x and y .

$$x + y = 10$$

$$x - y = 2$$

- Label the information on the bar model.



- Use the bar model to work out the values of x and y .

- The sum of two numbers, p and q , is 55

The difference between p and q is 7

Show this as a bar model and find the values of p and q .

- The sum of x and y is 12

x is 3 times the size of y .

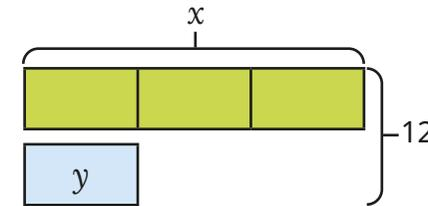

- Explain how you can use the bar model to work out the value of y .

- What is the value of x ?

Are there any other possible solutions?

- The sum of two numbers, a and b , is 18

a is one-fifth the size of b .

Draw a bar model to represent this problem and work out the values of a and b .

- Tom and Ann both go for a walk.

Between them they walk 21 km.

Tom walks 6 times as far as Ann does.

How much further does Tom walk than Ann?

Solve problems with two unknowns

Reasoning and problem solving

The sum of x and y is 40

x is 4 times the size of y .

What is the value of y ?

$y = 10$, because
40 divided by 4 is
equal to 10



Show that Tiny is wrong.

Find the correct values of x and y .

If $y = 10$, $x = 40$ and
 $x + y = 50$

$y = 8$ and $x = 32$

Two apples and three bananas
cost £1.02

Two apples and five bananas
cost £1.46

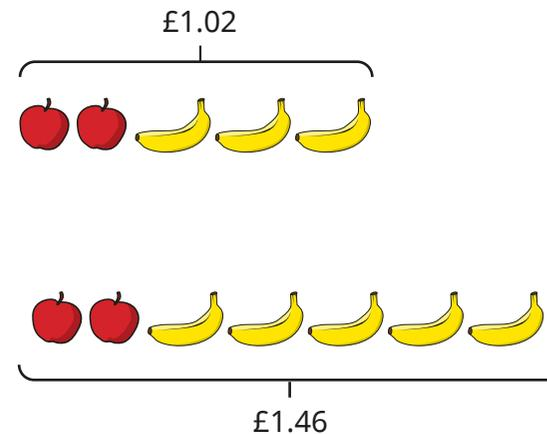

What is the total cost of one apple
and one banana?

40p

Spring Block 3

Decimals

Small steps

Step 1

Place value within 1

Step 2

Place value – integers and decimals

Step 3

Round decimals

Step 4

Add and subtract decimals

Step 5

Multiply by 10, 100 and 1,000

Step 6

Divide by 10, 100 and 1,000

Step 7

Multiply decimals by integers

Step 8

Divide decimals by integers



Small steps

Step 9

Multiply and divide decimals in context



Place value within 1

Notes and guidance

Children encountered numbers with up to 3 decimal places for the first time in Year 5. This understanding is recapped in this small step and built upon in the rest of the block.

Children represent numbers with up to 3 decimal places using counters and place value charts, identify the values of the digits in a decimal number and partition decimal numbers in a range of ways.

Children know the relationship between the different place value columns, for example hundredths are 10 times the size of thousandths and one-tenth the size of tenths.

In this step, numbers are kept within 1 to allow children to focus on the value of the decimal places. In the next step, they explore numbers greater than 1 with up to 3 decimal places.

Things to look out for

- Children may confuse the words “thousand” and “thousandth”, “hundred” and “hundredth”, and “ten” and “tenth”.
- Children may use the incorrect number of placeholders, and so write the incorrect number.

Key questions

- What does each digit in a decimal number represent? How do you know?
- How many tenths/hundredths/thousandths are there in 1 whole?
- How many thousandths are there in 1 hundredth?
- What is the value of the digit _____ in the number _____?
- Which is greater, 0.3 or 0.14? How do you know?

Possible sentence stems

- There are _____ tenths, _____ hundredths and _____ thousandths.
The number is _____
- There are _____ in _____
- _____ is 10 times/one-tenth the size of _____

National Curriculum links

- Identify the value of each digit in numbers given to 3 decimal places and multiply and divide numbers by 10, 100 and 1,000 giving answers up to 3 decimal places

Place value within 1

Reasoning and problem solving



The more decimal places a number has, the smaller the number is.

Do you agree with Tiny?
Explain your answer.



No

0	Tth	Hth	Thth

Use four counters to make a number less than 1

What is the value of each digit in your number?

How many ways can you partition it?

multiple possible answers

0.454

0.44

0.445

0.345



The children are each thinking of a different decimal number.



My number has four hundredths.

Amir



My number is the smallest.

Alex



The sum of the digits in my number is 13

Dora



The tenths and hundredths digits in my number are different.

Dexter

Match each number to the correct child.

Amir: 0.44
Alex: 0.345
Dora: 0.445
Dexter: 0.454

Place value – integers and decimals

Notes and guidance

In this small step, children continue to explore numbers with 3 decimal places, now extending to numbers greater than 1

As in the previous step, children use counters and place value charts to represent numbers greater than 1 with up to 3 decimal places, identify the value of the digits in a decimal number and partition decimal numbers in a range of ways. They can describe the difference between integer and decimal parts of numbers, for example recognising 3 tens and 3 tenths.

Children understand the relationship between the different place value columns, for example knowing that tenths are 10 times the size of hundredths and one-tenth the size of ones ($0.01 \times 10 = 0.1$, $1 \div 10 = 0.1$). Number lines and thousand squares are helpful representations for exploring these relationships.

Things to look out for

- Children may confuse the words “thousand” and “thousandth”, “hundred” and “hundredth”, and “ten” and “tenth”.
- Children may use the incorrect number of placeholders, and so write the incorrect number.

Key questions

- What does a decimal number represent?
- How many tenths/hundredths/thousandths are there in 1 whole?
- How many thousandths are there in 1 hundredth?
- What digit is in the _____ column?
- What is the value of the digit _____ in the number _____?
- Which is greater, 1.897 or 3.1? How do you know?

Possible sentence stems

- There are _____ ones, _____ tenths, _____ hundredths and _____ thousandths.
The number is _____
- There are _____ in _____
- _____ is 10/100/1,000 times the size of _____
- _____ is one-tenth/hundredth/thousandth the size of _____

National Curriculum links

- Identify the value of each digit in numbers given to 3 decimal places and multiply and divide numbers by 10, 100 and 1,000 giving answers up to 3 decimal places

Place value – integers and decimals

Key learning

- Use the cards to complete the sentences in as many ways as possible.



_____ are 10 times the size of _____
 _____ are one-tenth the size of _____
 _____ are 100 times the size of _____
 _____ are one-hundredth the size of _____
 _____ are 1,000 times the size of _____
 _____ are one-thousandth the size of _____

- Complete the sentences to describe the number.

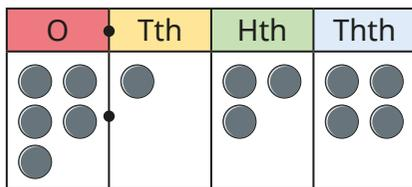

There are _____ ones, _____ tenth, _____ hundredths and _____ thousandths.

The number is _____

- Use a place value chart and plain counters to represent the numbers.

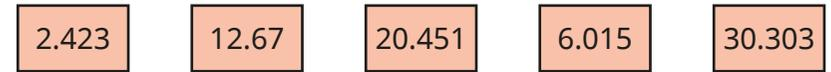

- What is the value of the 3 in each number?



- What decimal numbers are the arrows pointing to?

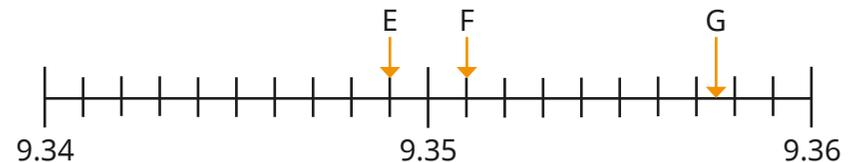
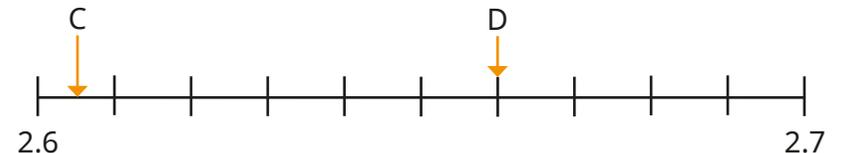
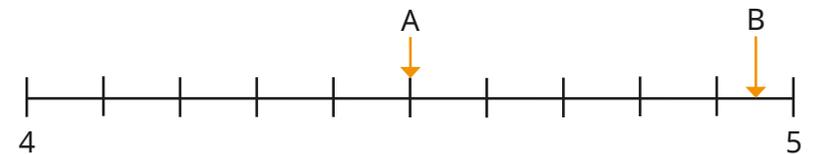

Place value – integers and decimals

Reasoning and problem solving

Which is the odd one out?

- A** $2 + 0.1 + 0.02 + 0.003$
- B** $1 + 1.1 + 0.02 + 0.003$
- C** $2 + 1.1 + 0.03$
- D** $2 + 0.1 + 0.01 + 0.013$
- E** $2 + 0.1 + 0.023$

Explain your answer.

Create your own question like this for a partner.



C
C is 3.13, but all the other numbers are 2.123

O	Tth	Hth	Thth

Use five plain counters to make a number greater than 1

What is the value of each digit in your number?

How many ways can you partition it?

multiple possible answers

Is the statement always true, sometimes true or never true?



A number with 3 decimal places is greater than a number with only 1 decimal place.

sometimes true

Explain your answer.



Round decimals

Notes and guidance

In Year 5, children learnt to round numbers with up to 2 decimal places to the nearest integer and to 1 decimal place. It may be helpful to recap some of this learning before beginning this step. In this small step, children round numbers with up to 3 decimal places to the nearest integer and tenth (1 decimal place), as well as rounding to the nearest hundredth (2 decimal places) for the first time.

It is vital that children can identify the multiples of 1, 0.1 and 0.01 before and after any number with up to 3 decimal places. Children can then explore which multiple is closer, to help decide what a number should be rounded to. As with all rounding, the use of number lines can help with this process. Children recognise that when asked to round to a given degree of accuracy, they look at the place value column to the right; if the digit is 0 to 4, they round to the previous multiple and if it is 5 to 9, they round to the next multiple.

Things to look out for

- The phrase “round down” can lead children to round too low, for example rounding 6.923 down to 6.91 rather than 6.92

Key questions

- What is the next/previous integer/tenth/hundredth?
- Using the number line, which multiple of _____ is _____ closer to?
- If you are rounding to the nearest _____, which column do you need to look at to decide where to round to?
- If the digit in this column is between 0 and 4, which multiple should you round to?
- Which multiple should you round to if the digit is a 5?

Possible sentence stems

- The previous/next multiple of _____ is _____
_____ is closer to _____ than _____
So _____ rounded to the nearest _____ is _____

National Curriculum links

- Solve problems which require answers to be rounded to specified degrees of accuracy

Round decimals

Key learning

- Complete the table.

Number	3.472	2.196	0.804
Previous integer	3		
Next integer	4		
Previous tenth	3.4		
Next tenth	3.5		
Previous hundredth	3.47		
Next hundredth	3.48		

- Use the number line to complete the sentences.

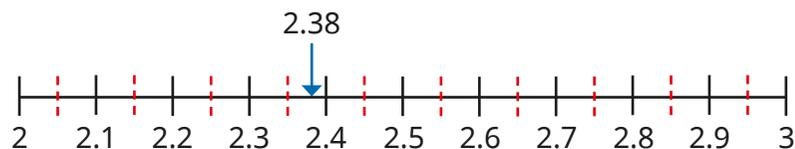

2.38 is closer to 2 than 3

2.38 rounded to the nearest integer is _____

2.38 is closer to 2.4 than 2.3

2.38 rounded to the nearest tenth is _____

- Use the number line to complete the sentences.

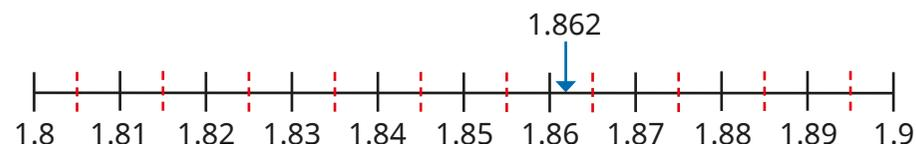

1.862 is closer to _____ than _____

1.862 rounded to the nearest hundredth is _____

- Complete the sentences to round 4.615 to different degrees of accuracy.

▶ 4.615 is closer to _____ than _____

4.615 rounded to the nearest hundredth is _____

▶ 4.615 is closer to _____ than _____

4.615 rounded to the nearest tenth is _____

▶ 4.615 is closer to _____ than _____

4.615 rounded to the nearest integer is _____

- Round the numbers to the nearest hundredth, tenth and integer.

2.473

10.185

7.084

19.987

Round decimals

Reasoning and problem solving

Here are some number cards.

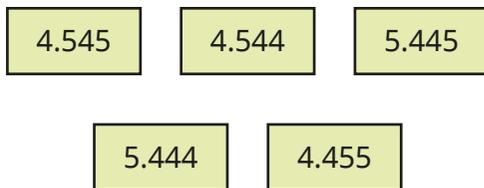

Use each number once only to complete the sentences.

- _____ rounded to the nearest tenth is 4.5
- _____ rounded to the nearest integer is 4
- _____ rounded to the nearest tenth is 5.4
- _____ rounded to the nearest hundredth is 5.45
- _____ rounded to the nearest hundredth is 4.54

4.545 4.455 5.444 5.445 4.544

Use the digit cards to make the statements correct.

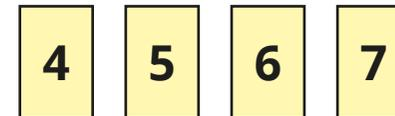

You may use each card once only.

- .803 rounded to the nearest integer is 6
- 5.9 rounded to the nearest tenth is 6
- 6. rounded to the nearest integer is 6
- .002 rounded to the nearest hundredth is 6

5.803 5.97 6.4 6.002

Add and subtract decimals

Notes and guidance

In Year 5, children added and subtracted numbers with up to 3 decimal places. In this small step, children revise the methods used for adding and subtracting numbers with different numbers of decimal places and numbers where exchanging between columns is needed.

Use place value counters in a place value chart alongside the formal written method to help children with their understanding. Begin with the smallest place value column when adding or subtracting, while at each stage asking: “Can you make an exchange?” Care must be taken when numbers have the same number of digits, but belong in different place value columns, for example $1.23 + 45.6$. The use of zero placeholders can support with this. Bar models and part-whole models can be used alongside concrete resources to help children understand what calculation needs to take place.

Things to look out for

- Children may not line up digits in the correct place value columns.
- When an exchange is needed in addition, children may forget to add the exchanged number.
- Children may forget to put the decimal point in their answer.

Key questions

- How can you represent this question using place value counters?
- Do you have enough _____ to make an exchange?
- Do you need to exchange any _____?
- What are 10 tenths/10 hundredths/10 thousandths equal to?
- If there are not enough tenths/hundredths/thousandths for the subtraction, what do you need to do?

Possible sentence stems

- _____ added to _____ is equal to _____
- _____ subtract _____ is equal to _____
- _____ tenths added to _____ tenths is equal to _____ tenths.

I do/do not need to make an exchange because ...

National Curriculum links

- Solve addition and subtraction multi-step problems in contexts, deciding which operations and methods to use and why

Add and subtract decimals

Key learning

- Whitney is working out $42.6 + 3.02$ using a place value chart.

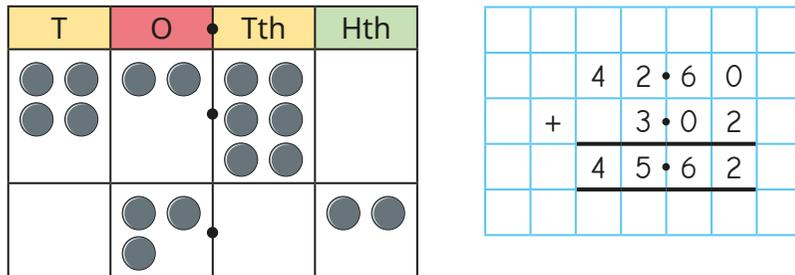

Use Whitney's method to work out the calculations.

$503.6 + 25.35$
 $56.95 - 32.8$
 $31.67 + 1.319$
 $249.45 - 18.3$

- Ron is finding the total of 0.64 and 0.27



How does Ron know this?

Use a place value chart and counters to find the total of 0.64 and 0.27

- Use a place value chart and counters to complete the calculations.

$0.46 + 0.28$
 $0.73 - 0.29$
 $1.067 + 0.274$
 $23.517 - 12.187$

- Use place value counters to show that $1.035 + 0.18 = 1.215$

- Use a place value chart to help work out the calculations.

$0.468 + 1.25$
 $5.687 + 0.97$
 $15.027 + 9.58$

- Esther uses place value counters to work out $1.615 - 0.64$

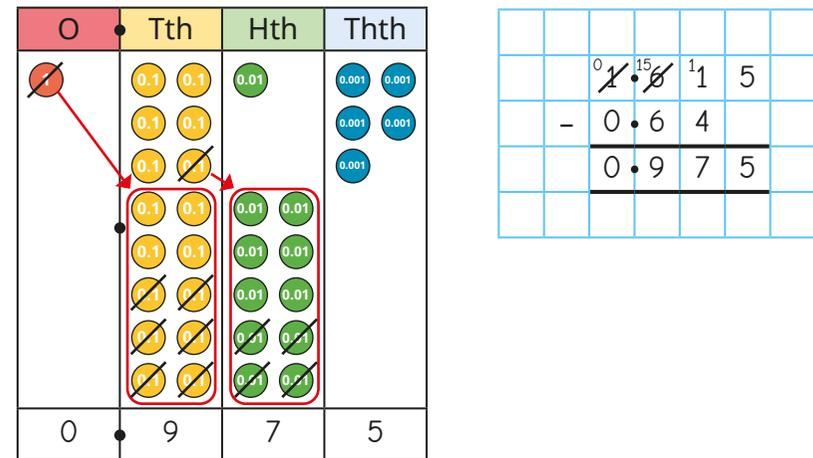

Use Esther's method to work out the calculations.

$0.468 - 0.28$
 $5.71 - 0.815$
 $16.904 - 7.85$

Add and subtract decimals

Reasoning and problem solving



Tiny has represented $16.53 + 5.485$ on a place value chart.

T	O	Tth	Hth	Thths
●	●●●●	●●●●	●●	
●●●●	●●●●	●●●●	●●●●	

What mistake has Tiny made?

Represent the calculation correctly.

What is the correct answer?

22.015

Work out the perimeter of this shape.

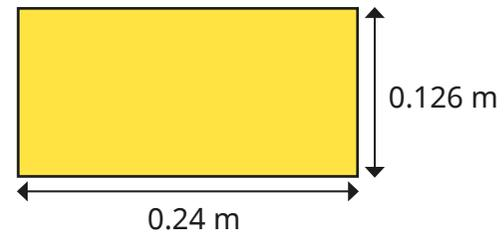

This rectangle has a perimeter of 0.866 m.

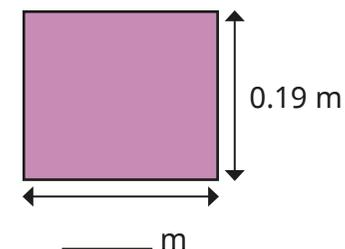

Work out the missing length.

0.732 m

0.243 m

Multiply by 10, 100 and 1,000

Notes and guidance

In Year 5, children multiplied numbers with up to 2 decimal places by 10, 100 and 1,000. This small step extends to numbers with up to 3 decimal places.

Children use place value counters to represent multiplying a decimal number by 10, leading to an exchange being needed. Children see that when multiplying by 10, they exchange for a counter that goes in the place value column to the left. Children then explore how multiplying by 100 is the same as multiplying by 10 and then 10 again, so digits move two place value columns to the left. Finally, they look at multiplying by 1,000

A Gattegno chart and plain counters in a place value chart are also used to help children with their understanding.

Things to look out for

- Children may add a zero when multiplying a decimal number by 10, or two zeros when multiplying by 100, for example $5.13 \times 10 = 5.130$
- Children may think of the multiplication as moving the decimal point, but it is important to refer to the digits moving instead as they become, for example, 10 times greater.

Key questions

- How can you represent multiplying a decimal number with place value counters?
- What number is 10 times the size of _____?
- What number is 100 times the size of _____?
- What number is 1,000 times the size of _____?
- How can you multiply decimal numbers using a Gattegno chart?
- How can you use counters on a place value chart to multiply numbers by 10/100/1,000?

Possible sentence stems

- _____ is 10/100/1,000 times the size of _____
- _____ is one-tenth/hundredth/thousandth the size of _____
- To multiply by _____, I move the digits _____ places to the _____

National Curriculum links

- Identify the value of each digit in numbers given to 3 decimal places and multiply and divide numbers by 10, 100 and 1,000 giving answers up to 3 decimal places

Multiply by 10, 100 and 1,000

Key learning

- Tommy uses place value counters to multiply 1.21 by 10

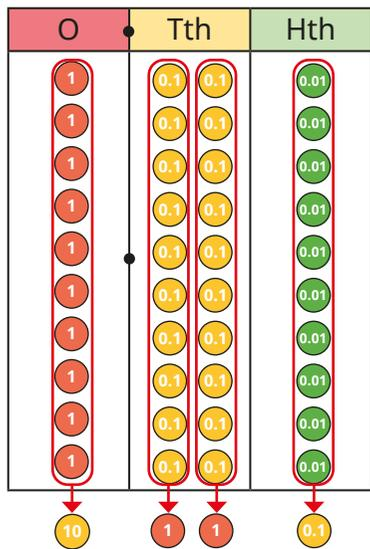

$1.21 \times 10 = 12.1$
 12.1 is 10 times the size of 1.21
 1.21 is one-tenth the size of 12.1

Use Tommy's method to work out the calculations and complete the sentences for each one.

2.43×10
 1.05×10
 0.03×10
 4.1×10

_____ $\times 10 =$ _____
 _____ is 10 times the size of _____
 _____ is one-tenth the size of _____

- Jack uses a Gattegno chart to work out that $0.46 \times 100 = 46$

10	20	30	40	50	60	70	80	90
1	2	3	4	5	6	7	8	9
0.1	0.2	0.3	0.4	0.5	0.6	0.7	0.8	0.9
0.01	0.02	0.03	0.04	0.05	0.06	0.07	0.08	0.09

Use a Gattegno chart to work out the calculations.

- ▶ 0.19×100
 ▶ 2.05×100
 ▶ 1.513×100

- Nijah multiplies 0.213 by 1,000 using a place value chart.

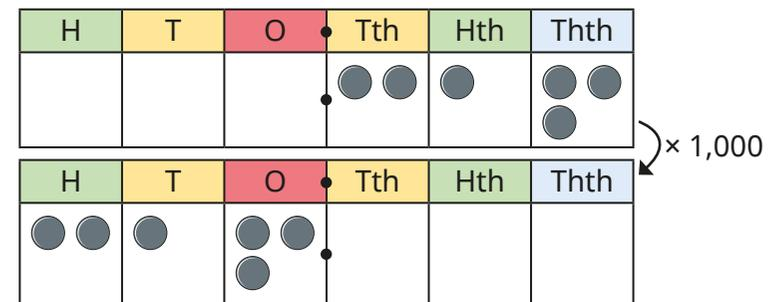

$0.213 \times 1,000 = 213$
 213 is 1,000 times the size of 0.213. 0.213 is one-thousandth the size of 213

Use Nijah's method to work out the calculations.

$0.32 \times 1,000$
 $0.298 \times 1,000$
 $1.045 \times 1,000$
 $5.407 \times 1,000$

Multiply by 10, 100 and 1,000

Reasoning and problem solving

Tiny is multiplying numbers by 100

When you multiply by 100, you just add two zeros to the end of the number.



Give an example of a calculation where Tiny's method works.

Give an example of a calculation where Tiny's method does **not** work.

What is a better way to explain how to multiply by 100?

Talk about it with a partner.

e.g. 3×100

e.g. 0.3×100

Fill in the missing numbers.

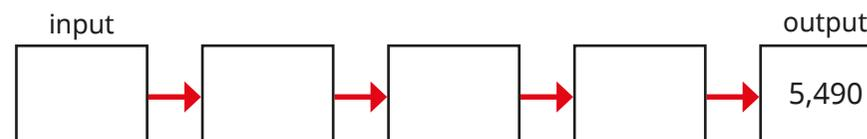
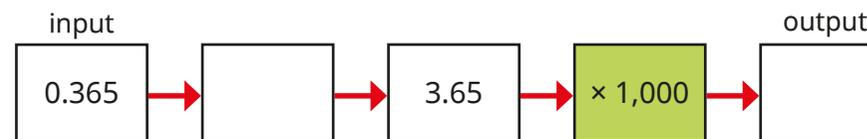
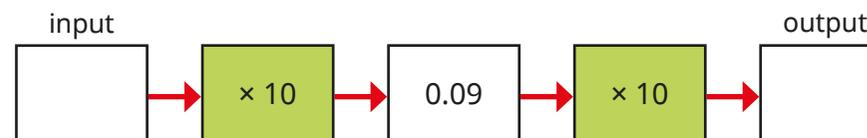
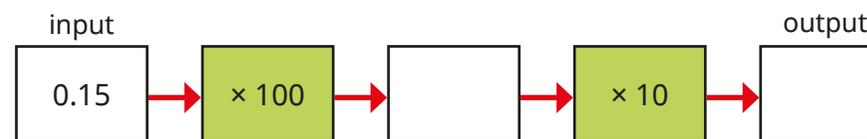

15, 150

0.009, 0.9

× 10, 3,650

multiple possible answers, e.g.
 0.549×10 , $5.49 \times 1,000$

Divide by 10, 100 and 1,000

Notes and guidance

In the previous step, children multiplied numbers with up to 3 decimal places by 10, 100 and 1,000. In this small step, they divide whole and decimal numbers by 10, 100 and 1,000. The answers will never have more than 3 decimal places.

Children use place value counters to represent a decimal number being divided by 10. As with the previous step, using language such as “10 times the size” and “one-tenth of the size” will support children in their understanding.

Children recognise that dividing a number by 10 twice is the same as dividing the number by 100. They then use a place value chart with counters (and then digits) to divide a number by 10, 100 or 1,000 by moving the counters the correct number of places to the right. A Gattegno chart used in the same way as in the previous step will also help children understand what happens to numbers as they are divided by powers of 10

Things to look out for

- Children may try to remove a zero when dividing by 10, two zeros when dividing by 100 and so on.
- Children may move the decimal point as well as the digits. Encourage them to move digits to the right as they become, for example, one-tenth of the size.

Key questions

- How can you represent dividing a decimal number with place value counters?
- What is one-tenth the size of _____?
- What is one-hundredth the size of _____?
- What is one-thousandth the size of _____?
- How can you divide decimal numbers using a Gattegno chart?
- How can you use counters on a place value chart to divide numbers by 10/100/1,000?

Possible sentence stems

- _____ is 10/100/1,000 times the size of _____
- _____ is one-tenth/hundredth/thousandth the size of _____
- To divide by _____, I move the digits _____ places to the _____

National Curriculum links

- Identify the value of each digit in numbers given to 3 decimal places and multiply and divide numbers by 10, 100 and 1,000 giving answers up to 3 decimal places

Divide by 10, 100 and 1,000

Key learning

- Alex divides 0.12 by 10 using place value counters.

1 tenth = 10 hundredths
1 hundredth = 10 thousandths
 $0.12 \div 10 = 0.012$

Use Alex's method to work out the calculations and complete the sentences for each one.

$2.43 \div 10$
 $1.05 \div 10$
 $0.03 \div 10$
 $4.1 \div 10$

_____ is 10 times the size of _____
_____ is one-tenth the size of _____

- Here are two division facts.

$2.5 \div 10 = 0.25$
 $0.25 \div 10 = 0.025$

- ▶ Explain why this means that $2.5 \div 100 = 0.025$
- ▶ Use this method to work out the divisions.

$6.1 \div 100$
 $0.8 \div 100$
 $25.3 \div 100$
 $7 \div 100$

- Amir uses a place value chart to divide 312 by 1,000

$312 \div 1,000 = 0.312$
312 is 1,000 times the size of 0.312
0.312 is one-thousandth the size of 312

Use Amir's method to work out the divisions.

$9 \div 1,000$
 $45 \div 1,000$
 $508 \div 1,000$
 $2,060 \div 1,000$

- Complete the table.

	30	3 kg			
$\div 10$			0.9		
$\div 100$					0.09
$\div 1,000$				9	

Divide by 10, 100 and 1,000

Reasoning and problem solving

Tiny is dividing numbers by 10, 100 and 1,000

When you divide by 10, 100 or 1,000, you just remove the zeros.



Do you agree with Tiny?
Explain your answer.

No

For example:
For $24 \div 10$, there are no zeros to remove.
For $107 \div 10$, you cannot just remove the zero to leave 17

Use the rules and the table to make 70 in as many ways as you can.

- Use a number from column A.
- Use an operation from column B.
- Use a number from column C.

A	B		C
7	×	÷	1
70			10
700			100
7,000			1,000

multiple possible answers, e.g.
 7×10

Is the statement true or false?

Dividing by 1,000 is the same as dividing by 10 three times.

Explain your answer.

True

Multiply decimals by integers

Notes and guidance

In this small step, children multiply numbers with up to 2 decimal places by integers other than 10, 100 and 1,000 for the first time.

Children look at related multiplication facts using concrete resources such as place value counters, exploring relationships such as $3 \times 2 = 6$ and $0.3 \times 2 = 0.6$, and $5 \times 5 = 25$ and $0.5 \times 5 = 2.5$. They then multiply numbers with up to 2 decimal places by 1-digit integers using rows of place value counters, exchanging when needed. This is a good opportunity to explore calculations with money.

Most of the learning focuses on multiplying by a 1-digit number, but it may be appropriate to explore methods for multiplying by a 2-digit number, for example partitioning the integer and using knowledge of multiplying by 10 to support the workings:

$$0.4 \times 14 = (0.4 \times 10) + (0.4 \times 4).$$

Things to look out for

- Children may make mistakes with exchanges where decimals are involved, for example thinking that $0.5 \times 3 = 0.15$
- When using related facts to multiply decimals, children may put the answer as 100 times smaller instead of 10 times smaller, for example $1.2 \times 3 = 0.36$

Key questions

- What is an integer?
- If you know $3 \times 2 = 6$, what else do you know?
- How can you show multiplying decimals by integers using counters?
- How is multiplying decimal numbers similar to/different from multiplying whole numbers?
- Do you have enough hundredths/tenths/ones to make an exchange?

Possible sentence stems

- I need to exchange 10 _____ for 1 _____
- I know that _____ \times _____ = _____, so I also know that _____ \times _____ = _____
- _____ multiplied by _____ is equal to _____

National Curriculum links

- Multiply 1-digit numbers with up to 2 decimal places by whole numbers

Multiply decimals by integers

Key learning

- Dora uses place value counters to show that 6 lots of 2 is 12, and 6 lots of 0.2 is 1.2

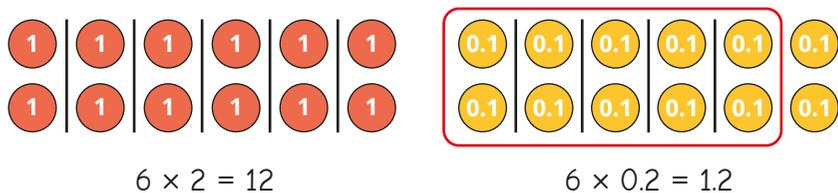

Use Dora's method to complete the calculations.

- ▶ 4 × 2 ▶ 5 × 5 ▶ 3 × 4 ▶ 12 × 3
- 4 × 0.2 0.5 × 5 3 × 0.4 1.2 × 3

- Dexter uses place value counters to work out 3.42 × 3

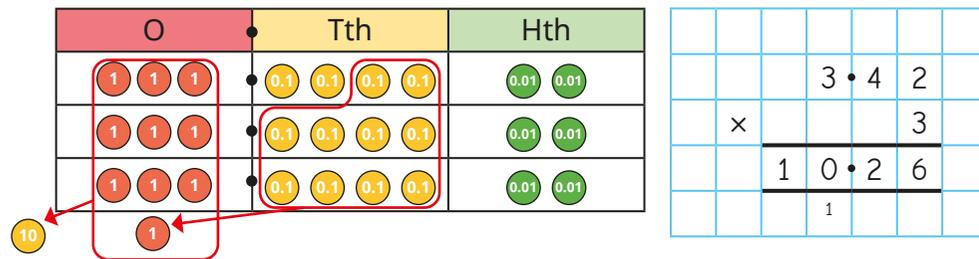

Use Dexter's method to work out the multiplications.

- 2.31 × 4 3.75 × 3 0.55 × 2 1.08 × 3

- Aisha and Filip are using counters to work out multiplications.

Aisha: 213 × 4 = 852

Filip: 2.13 × 4 = 8.52

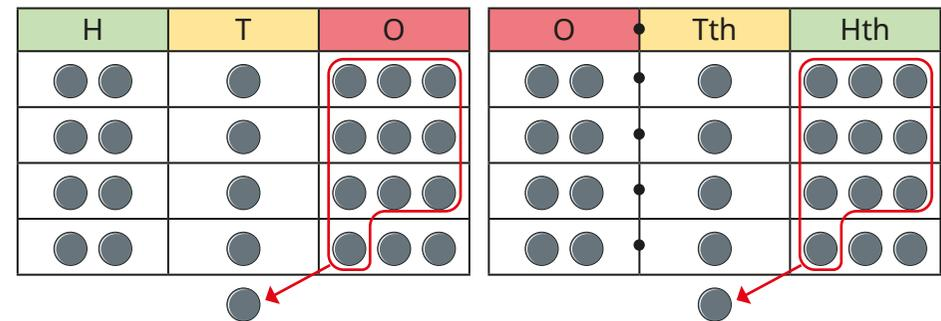

What is the same and what is different about their calculations?

- Use the place value counters to multiply 1.212 by 3

Complete the calculation.

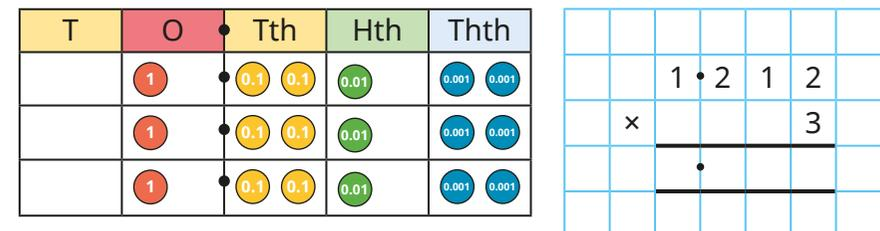

- Use place value counters and a formal written multiplication to work out the calculations.

- 2.121 × 4 0.613 × 5 4.056 × 3

Multiply decimals by integers

Reasoning and problem solving



I know that
 $25 \times 4 = 100$,
 so $0.25 \times 4 = 0.100$

Do you agree with Tiny?
 Explain your answer.

No

Is the statement always true, sometimes true or never true?

When you multiply a number with 2 decimal places by an integer, the answer will have 2 decimal places.

Explain your answer.

sometimes true

Chocolate eggs can be bought individually, or in packs of 6 or 8

 <p>1 egg 52p</p>
 <p>6 eggs £2.85</p>
 <p>8 eggs £4</p>

What is the cheapest way for Max to buy 25 chocolate eggs?
 How much will he spend?

four packs of 6 plus an individual egg

£11.92

Divide decimals by integers

Notes and guidance

In this small step, children divide decimals by integers other than 10, 100 or 1,000 for the first time.

Children look at related division facts, such as $8 \div 2 = 4$ therefore $0.8 \div 2 = 0.4$ and $0.08 \div 2 = 0.04$. Explore the pattern that as the number being divided becomes 10 or 100 times smaller, the answer becomes 10 or 100 times smaller, modelling this using place value counters in a place value chart.

Children explore a range of division facts using times-table knowledge, for example $144 \div 12 = 12$, so $1.44 \div 12 = 0.12$. Using place value counters, children put counters into groups, starting with the greatest place value column. They start with division where no exchanges are needed before moving on to calculations needing exchanges. They use the formal written method for division alongside the place value charts.

Things to look out for

- When using related facts, children may make the number being divided one-hundredth the size, but only make the answer one-tenth the size, for example $8 \div 2 = 4$, so $0.08 \div 2 = 0.4$
- When using the formal written method for division, children may forget to add the decimal point.

Key questions

- If you know that $\text{_____} \div \text{_____} = \text{_____}$, what else do you know?
- If you make the number being divided one-tenth the size, what must you do to the answer?
- How can you show this division using place value counters?
- How many groups of _____ can you make with _____ ?
- What happens to tenths or hundredths that you cannot group?

Possible sentence stems

- I know that $\text{_____} \div \text{_____}$ is _____ , so I also know that $\text{_____} \div \text{_____}$ is _____
- If _____ ones divided by _____ is equal to _____ , then _____ tenths/hundredths divided by _____ is equal to _____

National Curriculum links

- Use written division methods in cases where the answer has up to 2 decimal places

Divide decimals by integers

Key learning

- Dani, Mo and Kim use place value counters to work out divisions.

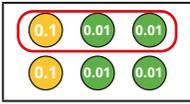
Dani	Mo	Kim
		
$24 \div 2 = 12$	$2.4 \div 2 = 1.2$	$0.24 \div 2 = 0.12$

What is the same about their divisions?
 What is different about their divisions?
 What do you notice?

- Use place value counters to work out the divisions.

▶ $4 \div 2$	▶ $9 \div 3$	▶ $36 \div 6$	▶ $15 \div 3$
$0.4 \div 2$	$0.09 \div 3$	$3.6 \div 6$	$0.15 \div 3$

- Use counters and a place value chart to work out the divisions.

$8.46 \div 2$	$0.84 \div 2$	$9.36 \div 3$	$9.03 \div 3$
---------------	---------------	---------------	---------------

- Scott uses place value counters in a place value chart to work out $5.32 \div 4$

He writes his calculation using the formal written method.

O	Tth	Hth
		
		
		
		
		
		
		
		

		1	•	3	3
	4	5	•	3	12

Use place value counters alongside the formal written method to work out the divisions.

$3.12 \div 2$	$7.32 \div 3$	$6.05 \div 5$
---------------	---------------	---------------

- Max has £7.48
 He shares this money equally between him and 5 friends.
 He puts the money left over in a pot.
 How much money does he put in the pot?

Divide decimals by integers

Reasoning and problem solving

Tiny uses place value counters to work out $3.27 \div 3$

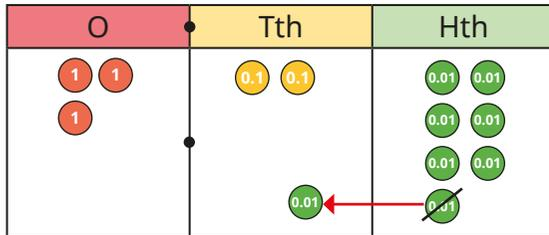

I only had two counters in the tenths column, so I moved one of the hundredths so each column could be grouped into 3s.



1.09

Explain why Tiny is incorrect.
What is the correct answer?



C is $\frac{1}{4}$ of A
 $B = C + 2$



Use this information to complete the division.

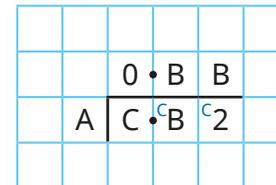

A = 4
B = 3
C = 1

Compare methods with a partner.



How did you work it out?

Create your own question like this for someone else to solve.

Multiply and divide decimals in context

Notes and guidance

This small step takes the skills explored in the previous two steps and applies them in a variety of contexts and problems.

Children recap the formal written methods for both multiplication and division alongside place value counters. They can use the same method with coins, with £1 coins replacing the ones, 10p coins replacing the tenths and 1p coins replacing the hundredths. Children then use these skills in a variety of contexts to solve problems.

Encourage children to use bar models to help them to identify what operation is needed and in what order steps should be taken.

It may be useful to recap conversions of units of measure from earlier in the year before beginning this step.

Things to look out for

- Children may be unsure which operation is needed to solve a problem.
- When solving questions in context, children may forget the units of measure.
- If a unit conversion is needed, for example kilograms to grams, children may multiply or divide by the incorrect amount.

Key questions

- How can you tell what operation you need to perform to answer this question?
- How can you represent this question using place value counters?
- What do you need to work out?
- How can you draw a bar model to represent this problem?
- Do you need to convert any units of measure to answer this question?

Possible sentence stems

- _____ multiplied by _____ is _____
- _____ divided by _____ is _____

National Curriculum links

- Multiply 1-digit numbers with up to 2 decimal places by whole numbers
- Use written division methods in cases where the answer has up to 2 decimal places
- Solve problems involving addition, subtraction, multiplication and division

Multiply and divide decimals in context

Key learning

- The table shows the prices of items in a shop.

Item	Cost
Magazine	£2.24
Book	£5.25
CD	£3.49
DVD	£4.75

Esther wants to buy three magazines.

She uses coins in a place value chart alongside the formal written method to work out the total cost.

O	Tth	Hth
6	7	2

	2	2	4	
	×		3	
	6	7	2	
		1		

Use Esther's method to work out the costs of these items.

4 books	3 CDs	5 DVDs and 6 books
---------	-------	--------------------

- A box of chocolates costs 4 times as much as a chocolate bar.

Together they cost £7.55

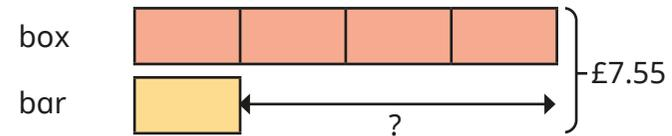

How much more does the box of chocolates cost than the chocolate bar?

- Modelling clay is sold in two different shops.
 - Shop A sells 4 pots of clay for £7.68
 - Shop B sells 3 pots of clay for £5.79

Which shop has the better deal?

Explain your answer.

- Huan has 9.6 litres of juice. He fills 8 identical jugs with the juice. How many millilitres of juice does each jug hold?
- A square has a perimeter of 0.824 m. How long is each side?

Multiply and divide decimals in context

Reasoning and problem solving

1.28 kg of sand is shared equally between 4 buckets.

There is 5.12 kg of sand in each bucket because $1.28 \times 4 = 5.12$



Explain the mistake that Tiny has made.

What is the mass of sand in each bucket?

0.32 kg

Annie has some money.

- She gives $\frac{2}{3}$ of her money to charity.
- She then buys three footballs costing £6.45 each.
- Her mum gives her and her two sisters £9.75 to share equally between them.



Now I have got £10.50

How much money did Annie have to start with?

£79.80

Spring Block 4

Fractions, decimals and percentages

Small steps

Step 1

Decimal and fraction equivalents

Step 2

Fractions as division

Step 3

Understand percentages

Step 4

Fractions to percentages

Step 5

Equivalent fractions, decimals and percentages

Step 6

Order fractions, decimals and percentages

Step 7

Percentage of an amount – one step

Step 8

Percentage of an amount – multi-step



Small steps

Step 9

Percentages – missing values



Decimal and fraction equivalents

Notes and guidance

In Year 5, children explored common equivalents between fractions and decimals. In this small step, they extend this learning to include more complex equivalents.

A hundred square is a useful representation to allow children to explore equivalence. Using fraction and decimal walls also enables children to see the relationship between fractions such as $\frac{1}{5}$ and $\frac{2}{10}$ and therefore their decimal equivalents.

They look at methods for finding more complex equivalents by finding a common denominator of 100. These should include examples where children need to simplify fractions with larger denominators, for example $\frac{146}{200}$

Things to look out for

- If children are not confident finding equivalent fractions, they may find converting more complex fractions to decimals difficult.
- Children may be comfortable with the idea of finding a common denominator of 100, but struggle with examples that do not lend themselves to this strategy, for example $\frac{1}{8}$

Key questions

- If the whole has been split into 10/100 equal parts, what is each part worth as a fraction/decimal?
- If you know that _____ is equivalent to _____, what is _____ as a decimal?
- How can you convert fractions with a denominator of 100 to decimals?
- How can you convert fractions with a denominator that is a factor of 100 to decimals?
- How can you find equivalent fractions?
- Why might it be helpful to find an equivalent fraction with a denominator of 100/1,000?

Possible sentence stems

- The first/second digit after a decimal point represents _____
- To find an equivalent fraction, I need to _____ or _____ the _____ and the _____ by the same number.

National Curriculum links

- Use common factors to simplify fractions; use common multiples to express fractions in the same denomination

Decimal and fraction equivalents

Key learning

- The bar model is split into tenths.



- Complete the sentences.

The whole has been divided into _____ equal parts.

Each part is worth _____

As a fraction, this is written _____

- On a similar bar model, shade:

- 4 parts
- 5 parts
- 7 parts
- 10 parts

What decimal and what fraction is shown in each diagram?

- Use a blank hundred square.

- Complete the sentences to match the hundred square.

The whole has been divided into _____ equal parts.

Each part is worth _____

As a fraction, this is written _____

- On different hundred squares, shade:

- 9 parts
- 25 parts
- 75 parts
- 13 parts
- 50 parts
- 90 parts

What decimal and what fraction is shown in each of your hundred squares?

- Use the fraction and decimal walls to complete the equivalents.

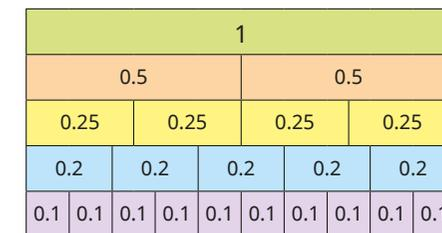
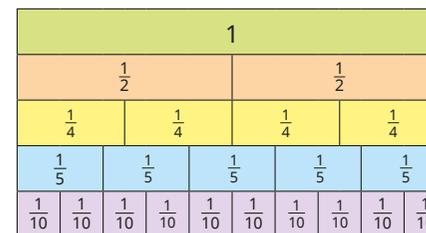

$$\frac{1}{2} = \frac{\square}{4} = \frac{\square}{10} = \dots$$

$$\frac{3}{4} = \dots$$

$$0.2 = \frac{1}{\square} = \frac{\square}{10}$$

$$\frac{4}{5} = \frac{\square}{\square} = \dots$$

- Rosie has converted three-quarters to a decimal.

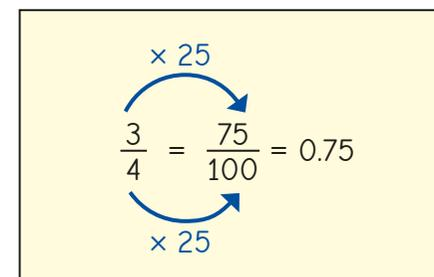

Use Rosie's method to find the decimal equivalents of the fractions.

$$\frac{17}{20}$$

$$\frac{23}{50}$$

$$\frac{11}{25}$$

$$\frac{112}{200}$$

$$\frac{275}{500}$$

$$\frac{192}{300}$$

Decimal and fraction equivalents

Reasoning and problem solving

Tiny wants to convert $\frac{137}{500}$ to a decimal.



I can divide 500 by 5 to get a denominator of 100, but then I cannot divide 137 by 5, so I cannot convert it to a decimal.



Explain a different method that Tiny could use.

Write $\frac{137}{500}$ as a decimal.



0.274

1							
$\frac{1}{2}$				$\frac{1}{2}$			
$\frac{1}{4}$		$\frac{1}{4}$		$\frac{1}{4}$		$\frac{1}{4}$	
$\frac{1}{8}$	$\frac{1}{8}$	$\frac{1}{8}$	$\frac{1}{8}$	$\frac{1}{8}$	$\frac{1}{8}$	$\frac{1}{8}$	$\frac{1}{8}$



To convert $\frac{1}{8}$ to a decimal, would you use an equivalent fraction with a denominator of 10, 100 or 1,000?

Use your choice to convert $\frac{1}{8}$ to a decimal.

Now use your answer to convert $\frac{3}{8}$ to a decimal.

Why is it easy to convert $\frac{4}{8}$ to a decimal?



1,000

0.125

0.375

Fractions as division

Notes and guidance

In this small step, children build on the learning from the previous step as they look at fractions as division to support them in converting between fractions and decimals.

Children explore the idea of fractions as divisions, learning that, for example $\frac{3}{4}$ can be interpreted as $3 \div 4$. They use place value counters to exchange ones for tenths and share them into equal groups to see that, for example, $\frac{1}{5} = 0.2$

Children progress to performing multiple exchanges to find other decimal equivalents. Once confident with this concept, they work with the more abstract short division method. It can be helpful to explore more complex examples, for example those that give recurring decimal answers, such as $\frac{1}{3} = 0.\dot{3}$

Things to look out for

- Children may interpret the division the wrong way around, for example $\frac{4}{5}$ as $5 \div 4$ rather than $4 \div 5$
- Children may need support to use extra zeros as placeholders when dividing, to avoid errors such as $3 \div 4 = 0.7$ remainder 2

Key questions

- If the denominator is _____, how many equal parts are there? What are you dividing by?
- Can you share 1 one into 4 equal parts? What can you exchange the 1 one for?
- What can you exchange the remaining _____ tenths for?
- What do you notice about the decimal parts when dividing 1 by 3?
- What does “recurring” mean?
- How do you know that $\frac{1}{2} = 2$ or $\frac{5}{8} = 1.6$ cannot be correct?

Possible sentence stems

- The fraction _____ can be expressed as _____ \div _____
- _____ \div _____ is the same as the fraction _____
- I can exchange 1 _____ for _____

National Curriculum links

- Associate a fraction with division and calculate decimal fraction equivalents for a simple fraction

Fractions as division

Key learning

- Write each fraction as a division.

▶ $\frac{3}{4}$ ▶ $\frac{7}{9}$ ▶ $\frac{112}{137}$

Write each division as a fraction.

▶ $2 \div 3$ ▶ $5 \div 8$ ▶ $24 \div 35$

- Aisha uses place value counters to convert $\frac{1}{2}$ to a decimal by dividing 1 whole by 2



$$\frac{1}{2} = 0.5$$

- ▶ Use Aisha's method to find the decimal equivalent of $\frac{1}{5}$
- ▶ Use place value counters to find the decimal equivalent of $\frac{1}{4}$

- Kim converts $\frac{3}{4}$ to a decimal.

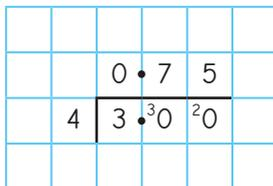

$$\frac{3}{4} = 0.75$$

Use Kim's method to find the decimal equivalent of each fraction.

▶ $\frac{2}{5}$ ▶ $\frac{4}{5}$ ▶ $\frac{3}{8}$ ▶ $\frac{5}{8}$

- Use division to find the decimal equivalents of $\frac{2}{3}$, $\frac{5}{6}$ and $\frac{2}{9}$
What do you notice?

- Teddy, Rosie and Jack have each found the decimal equivalent of $\frac{7}{8}$

Teddy	Rosie	Jack
$7 \div 8$ $\frac{7}{8} = 0.875$	$1 \div 8$ $\frac{1}{8} = 0.125$ $\frac{7}{8} = 7 \times 0.125$ $\frac{7}{8} = 0.875$	$1 \div 8$ $\frac{1}{8} = 0.125$ $\frac{7}{8} = 1 - 0.125$ $\frac{7}{8} = 0.875$

- ▶ Explain why each method works.
- ▶ Whose method do you prefer?
- ▶ Use your preferred method to find the decimal equivalent of $\frac{19}{20}$

Fractions as division

Reasoning and problem solving

Tiny uses division to find the decimal equivalent of $\frac{3}{5}$

		1	•	6	6	...	
3		5	•	20	20	...	

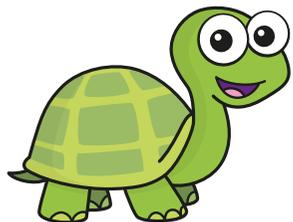

$$\frac{3}{5} = 1.66 \dots$$

Tiny worked out $5 \div 3$ instead of $3 \div 5$

0.6

How do you know that Tiny must be incorrect?

What mistake has Tiny made?

What is the correct answer?

Filip shares 7 large pizzas equally with 7 of his friends.

Esther shares 5 large pizzas with 5 of her friends.

Who gets more pizza, Filip or Esther?

Use decimals to help compare.

Filip

Annie has a plank of wood that is 1 metre long.



I have painted $\frac{5}{8}$ of the plank red.

0.625 m

62.5 cm

How long is the piece of wood that is painted red?

Give your answer in metres and then in centimetres.

Understand percentages

Notes and guidance

In this small step, children explore percentages. They were introduced to percentages for the first time in Year 5, learning that “per cent” relates to “the number of parts per 100” and that if the whole is split into 100 equal parts, then each part is worth 1%.

Using bar models, children split 1 whole into 10 equal parts to explore multiples of 10%. They estimate 5% on a bar model split into 10 equal parts by splitting a section in half, for example 45% is four full sections and half of another section. Other common percentages that are useful to explore are 50%, 25% and 20% by splitting the bar model into 2, 4 and 5 equal parts respectively. They then explore ways of making more complex percentages using a combination of these, for example $65\% = 50\% + 10\% + 5\%$.

It is important for children to recap knowledge of complements to 100 to allow them to see that, for example, $35\% + 65\% = 100\%$.

Things to look out for

- Children may think that 1% means 1 unit rather than 1 part out of 100 equal parts.
- If children are not confident with dividing 100 by 10, 5, 4 and 2, they may struggle to use bar models to find common percentages.

Key questions

- What does “per cent” mean?
- How many parts are shaded/not shaded?
- What does 100% mean?
- How many equal parts is the bar model split into? What percentage is each part worth?
- How many ways could you make 95% using 50%, 25%, 10%, 5% and 1%?

Possible sentence stems

- If the whole is shared into 100/10/5/4/2 equal parts, each part represents _____%.
- If _____ parts are shaded, the percentage shown is _____%.
- To find _____%, I can halve _____%.

National Curriculum links

- Recall and use equivalences between simple fractions, decimals and percentages, including in different contexts

Understand percentages

Key learning

- Here are some hundred squares.

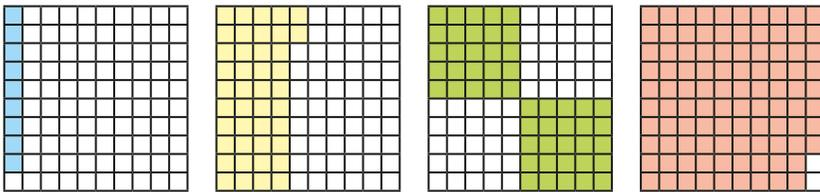

- ▶ How many parts out of 100 are shaded on each hundred square?
- ▶ What percentage of each hundred square is shaded?
- ▶ What percentage of each hundred square is **not** shaded?

What do you notice?

- What percentage of each bar model is shaded?

Use the sentences to help.

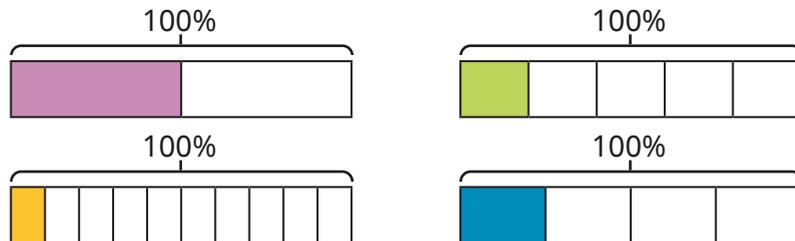

100% has been split into _____ equal parts.

Each part is worth _____%.

- Shade the percentages on the bar models.



- 45% of the bar model is shaded.

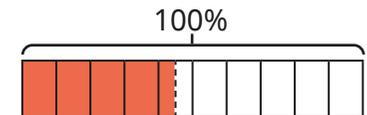

Draw bar models to show the percentages.



- Alex, Mo and Eva are exploring different ways of making 95%.

Alex

$$95\% = 9 \times 10\% + 5\%$$

Mo

$$95\% = 50\% + 25\% + 20\%$$

Eva

$$95\% = 100\% - 5\%$$

Explain each child's thinking.

Find four different ways of making each percentage.



Understand percentages

Reasoning and problem solving

Tiny is shading percentages on bar models.

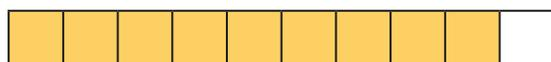

I have shaded 9% of the bar model.



Explain the mistake that Tiny has made.

What percentage of the bar model has Tiny shaded?

What would 9% look like on the bar model?



90%

Part of the first box shaded. Just under 10%

Tommy is comparing percentages.



25% is greater than 50%, because the green part is bigger than the purple part.



Do you agree with Tommy?

Explain your answer.



No

Fractions to percentages

Notes and guidance

In this small step, children recap Year 5 learning on equivalent fractions and percentages, using visual representations, before moving on to more abstract methods.

Children use hundred squares and bar models to explore equivalents, for example $\frac{1}{5}$ is the whole split into 5 equal parts and 100% split into 5 equal parts is 20%, so $\frac{1}{5} = 20\%$. They then explore the relationship with non-unit fractions, seeing that if $\frac{1}{4}$ is equal to 25%, then $\frac{3}{4} = 3 \times 25\% = 75\%$. More abstract methods allow children to convert more complex examples such as $\frac{11}{25}$.

They recognise that if they can find an equivalent fraction with a denominator of 100, then they can easily find percentage equivalences. Children explore examples where they are required to multiply (for example, $\frac{9}{20}$) or divide (for example, $\frac{132}{200}$).

Things to look out for

- Children need to be able to fluently find equivalent fractions.
- Children may not be confident with factors of 100, including 20 and 25

Key questions

- What is a percentage?
- If the whole is split into 100 equal parts, then what percentage is _____ parts equivalent to?
- How are percentages and fractions similar/different?
- If you know $\frac{1}{5}$ is equal to 20%, what percentage is $\frac{4}{5}$ equal to?
- How do you find an equivalent fraction?
- How many 20s/25s are there in 100?
- What do you know about the relationship between $\frac{1}{4}$ and $\frac{1}{8}$?

Possible sentence stems

- _____% is equivalent to $\frac{\square}{100}$
- $\frac{\square}{\square}$ is equivalent to $\frac{\square}{100}$ because ...
- The fraction $\frac{\square}{\square}$ is equivalent to _____%.

National Curriculum links

- Recall and use equivalences between simple fractions, decimals and percentages, including in different contexts

Fractions to percentages

Key learning

- Max uses a hundred square to convert $\frac{31}{100}$ to a percentage.

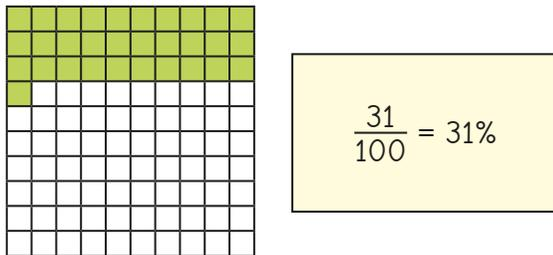

Shade hundred squares to show the fractions.

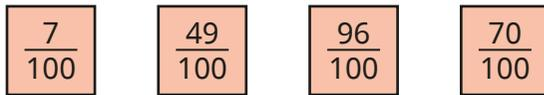

What percentage is shown on each hundred square?

- The bar models show that $\frac{1}{10}$ is equal to 10%.



Use the bar models to complete the statements.

▶ $\frac{3}{10} = \underline{\quad\quad}\%$ ▶ $\frac{9}{10} = \underline{\quad\quad}\%$ ▶ $\frac{\square}{100} = 50\%$ ▶ $\frac{\square}{\square} = 70\%$

- Whitney converts $\frac{3}{5}$ to a percentage.

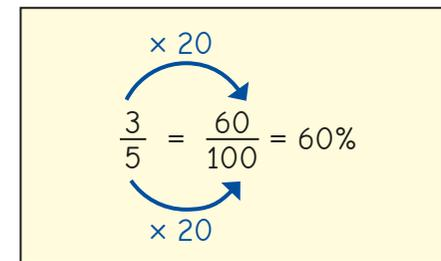

Use Whitney's method to convert the fractions to percentages.

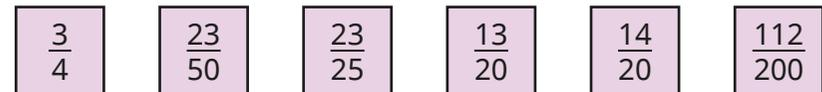

- $\frac{2}{5}$ of the people in a stadium have brown hair.

17% of the people have ginger hair.

$\frac{4}{25}$ of the people have black hair.

The rest have blonde hair.

What percentage of the people have blonde hair?

Fractions to percentages

Reasoning and problem solving



I know $\frac{2}{8}$ is equal to $\frac{1}{4}$ and $\frac{1}{4}$ is equal to 25%, so $\frac{2}{8}$ is also equal to 25%.

How can you use Ron's facts to work out $\frac{1}{8}$ as a percentage?

What is $\frac{1}{8}$ as a percentage?

12.5%

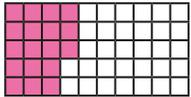

Huan thinks that 18% of the grid has been shaded.

Dora thinks that 36% of the grid has been shaded.

Who do you agree with?

Explain your answer.

Dora

In a maths test, Scott answered 58% of the questions correctly.

Nijah answered $\frac{2}{5}$ of the questions incorrectly.

Who answered more questions correctly?

Explain your reasoning.

Nijah

Tiny converts $\frac{13}{25}$ to a percentage.

$$\frac{13}{25} = \frac{13}{100} = 13\%$$

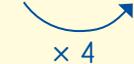

What mistake has Tiny made?

What is the correct percentage?

52%

Equivalent fractions, decimals and percentages

Notes and guidance

In this small step, children continue to explore the fraction, decimal and percentage equivalents that they began in Year 5

Children use hundred squares, bar models and number lines to recap equivalents to $\frac{1}{2}$, $\frac{1}{4}$, $\frac{1}{5}$ and $\frac{1}{10}$ as well as related non-unit fractions such as $\frac{3}{4}$, $\frac{2}{5}$ and $\frac{7}{10}$. They then look at more abstract methods of converting between fractions, decimals and percentages. Learning from the previous step is reinforced, in which equivalent fractions are found with a denominator of 100, allowing for a straightforward conversion to decimals and percentages. Children also convert decimals or percentages into a fraction with a denominator of 100 and then simplify where possible, for example $15\% = \frac{15}{100} = \frac{3}{20}$. This enables them to find equivalents to more complex numbers, such as 92% or 0.76

Things to look out for

- Children may not be confident with methods for finding equivalent fractions – both fractions with a denominator of 100 and those that need simplifying.

Key questions

- How many parts has the whole been split up into? What fraction is each part worth?
- If the whole is 100%, what is $\frac{1}{2}/\frac{1}{4}/\frac{1}{5}$?
- If $\frac{1}{10}$ is equal to 10%, what is $\frac{3}{10}$ equal to?
- How do you find equivalent fractions?
- How many 5s are there in 100?
- Can the fraction be simplified? How do you know?

Possible sentence stems

- If the whole is equal to 100%, then each part is worth _____%.
- If $\frac{1}{\square}$ is equal to _____%, then $\frac{\square}{\square}$ is equal to _____%.
- To find an equivalent fraction with a denominator of 100, I need to _____ by _____

National Curriculum links

- Recall and use equivalences between simple fractions, decimals and percentages, including in different contexts

Equivalent fractions, decimals and percentages

Key learning

- Complete the sentences to describe the hundred square.

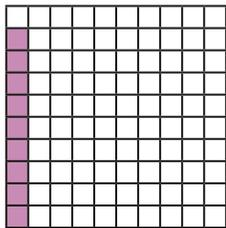

The fraction shaded is $\frac{\square}{100}$
 The decimal shaded is _____
 The percentage shaded is _____

- What are the fraction and decimal equivalents of 97%?
 What are the percentage and fraction equivalents of 0.23?

- What is the same about each bar model? What is different?

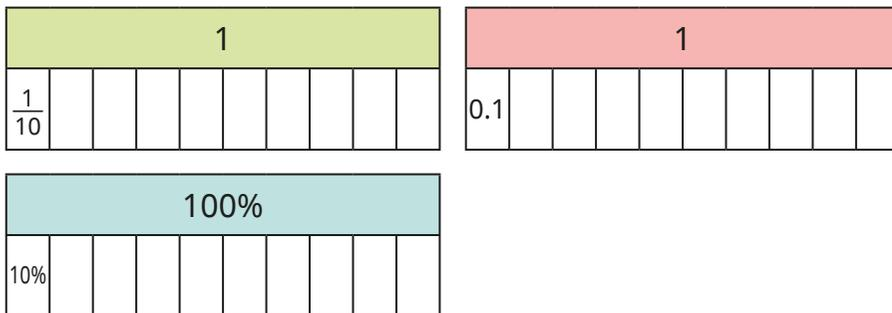

- ▶ Shade three parts of each bar model.
 What fraction, decimal and percentage is shaded?
- ▶ What other equivalent fractions, decimals and percentages can you find?

- Complete the number line to show the equivalent fractions, decimals and percentages.

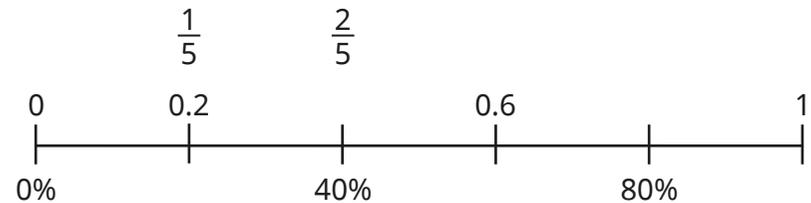

- Dexter converts $\frac{13}{20}$ to a decimal and a percentage.

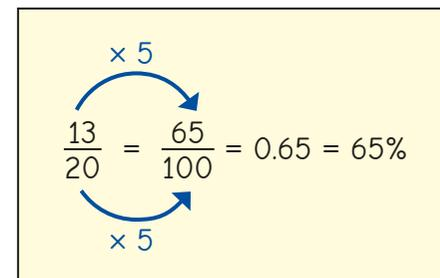

Explain Dexter's method.

Use Dexter's method to write each fraction as a decimal and as a percentage.



Equivalent fractions, decimals and percentages

Reasoning and problem solving

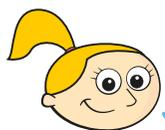

Eva

I know that 45% is equivalent to $\frac{45}{100}$

I know that 45% is equivalent to $\frac{9}{20}$



Amir

They are both correct, but Amir has written the fraction in its simplest form.

Who do you agree with?
Explain your reasoning.



$\frac{11}{25}$ and 44%

Which of these pairs are equivalent?

$\frac{11}{25}$ and 44%

$\frac{23}{50}$ and 23%

$\frac{17}{20}$ and 0.17

$\frac{49}{50}$ and 0.98

$\frac{49}{50}$ and 0.98

Complete the part-whole model.

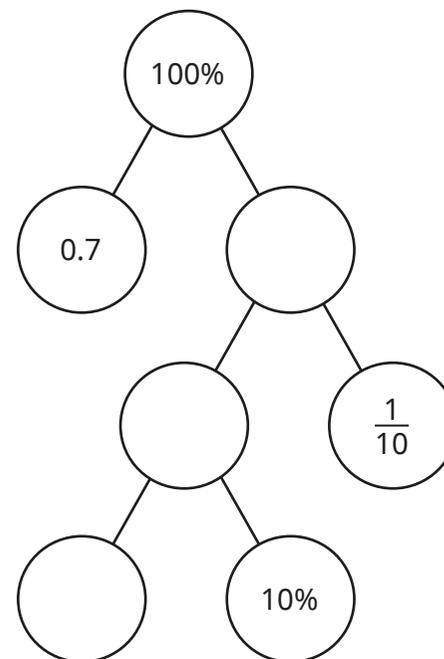

0.3, 30%, $\frac{30}{100}$, $\frac{3}{10}$
0.2, 20%, $\frac{20}{100}$, $\frac{2}{10}$, $\frac{1}{5}$
0.1, 10%, $\frac{10}{100}$, $\frac{1}{10}$

Is there more than one way to complete it? How do you know?

Create your own question like this for a partner.



Order fractions, decimals and percentages

Notes and guidance

In Year 5, children compared and ordered decimal numbers with up to 3 decimal places. In Year 6 Autumn Block 3, they ordered fractions with the same numerator or denominator. In this small step, they use their conversion skills from recent steps to order and compare fractions, decimals and percentages.

Children explore a range of strategies to compare and order numbers, including converting to the same form. Ask children to discuss if they prefer converting amounts to decimals, percentages or fractions and why. Children also look at strategies such as comparing amounts to a half and whether some amounts are closer or further away from the whole.

For consistency, use the word “greatest” rather than “biggest” or “largest” when comparing numbers.

Things to look out for

- Children may decimalise the percentage, for example 0.67%.
- Children may turn numerators into decimals or percentages even if the denominator is not 100, for example $\frac{45}{50} = 0.45 = 45\%$.

Key questions

- What fraction/decimal/percentage is _____ equivalent to?
- Which is the greater amount, _____ or _____? How do you know?
- Which of the amounts are greater than a half?
- Which of the amounts is closer to 1 whole?
- Where do these amounts go on a number line?
- Is it easier to convert the numbers to fractions, decimals or percentages?

Possible sentence stems

- _____ is greater/smaller than one half, and _____ is smaller/greater than one half, so _____ is greater/smaller than _____
- _____ is equivalent to _____, so it is greater/smaller than _____

National Curriculum links

- Compare and order fractions, including fractions >1
- Recall and use equivalences between simple fractions, decimals and percentages, including in different contexts

Order fractions, decimals and percentages

Key learning

- Teddy knows that $\frac{11}{20}$ is greater than a half and 42% is less than a half because it is less than 50%, so $\frac{11}{20}$ is greater than 42%. Use Teddy's method to write "greater" or "less" to complete the sentences.

- ▶ 0.45 is _____ than $\frac{16}{30}$
- ▶ $\frac{251}{500}$ is _____ than 15%.
- ▶ 50% is _____ than 0.309
- ▶ $\frac{13}{24}$ is _____ than 0.5

- Aisha knows that $\frac{9}{10}$ is closer to 1 whole than a half, but 52% is closer to a half than 1 whole, so $\frac{9}{10}$ is greater than 52%. Use Aisha's method to write <, > or = to compare the amounts.

$$0.61 \bigcirc 95\% \quad 0.809 \bigcirc \frac{26}{50} \quad 61\% \bigcirc \frac{33}{35}$$

- Kim converts $\frac{13}{20}$ to $\frac{65}{100}$, which is equivalent to 65%.

She uses this to recognise that $\frac{13}{20} < 67\%$.

Use Kim's method to write <, > or = to compare the amounts.

$$\frac{34}{50} \bigcirc 68\% \quad \frac{24}{25} \bigcirc 98\% \quad \frac{4}{10} \bigcirc 38\% \quad 44\% \bigcirc \frac{9}{20}$$

- Convert 0.38 and $\frac{1}{4}$ to percentages.

Use your conversions to write 45%, 0.38 and $\frac{1}{4}$ in ascending order.

- Order the numbers from greatest to smallest.

50%	$\frac{2}{5}$	0.45	$\frac{3}{10}$	54%	0.05
-----	---------------	------	----------------	-----	------

- Explain why $\frac{13}{10}$ is greater than 87%.

- Write <, > or = to compare the amounts.

$$\frac{2}{3} \bigcirc 1.1 \quad 105\% \bigcirc \frac{19}{20} \quad 1.01 \bigcirc 100\%$$

- Write the values in ascending order.

$\frac{1}{2}$	0.48	2.7	65%	$\frac{21}{20}$	49%
---------------	------	-----	-----	-----------------	-----

Compare methods with a partner.

Order fractions, decimals and percentages

Reasoning and problem solving



I know that 100% is greater than $\frac{13}{10}$ because 100 is greater than 13

Do you agree with Tiny?
Explain your answer.

No

Write a fraction, decimal and percentage that could complete the comparison.

$$\frac{3}{5} < \boxed{} < \frac{4}{5}$$

multiple possible answers, e.g.

$\frac{7}{10}$, 70%, 0.7,
 $\frac{13}{20}$, 75%, 0.78

Is the statement true or false?

There is no fraction, decimal or percentage that is greater than $\frac{99}{100}$, 0.99 or 99%, but smaller than 1 whole.

Explain your answer.

False

Mo wants to write the numbers in descending order.

87%	0.19	$\frac{17}{15}$
0%	2.19	$\frac{4}{8}$



I am going to convert them all to percentages.

Explain why Mo does not need to do this.

Write the numbers in descending order.

2.19, $\frac{17}{15}$, 87%,
 $\frac{4}{8}$, 0.19, 0%

Percentage of an amount – one step

Notes and guidance

In this small step, children calculate percentages of amounts for the first time. Children are familiar with finding fractions of amounts, but it may be worth recapping this before moving on to percentages.

Children find percentages of amounts that can be completed in one step, for example finding 1%, 10%, 20%, 25% and 50% by dividing by 100, 10, 5, 4 and 2 respectively. Using bar models to represent this allows children to see the links to finding fractions of amounts. They explore different strategies for dividing by these amounts, looking for the most efficient method for the calculation, including moving the digits when dividing by 10 and 100, halving and halving again for dividing by 4, as well as the formal written division method.

Things to look out for

- Knowing that to find 10% of a number they divide by 10 may confuse some children, leading to misconceptions such as dividing by 20 to find 20%.
- Children may answer every question by dividing the number by 100 to find 1% and then multiplying, rather than solving in one step.

Key questions

- How are percentages and fractions similar/different?
- How do you find a fraction of an amount?
- How can you represent this question with a bar model?
- How many lots of 10/20/25/50% are there in 100%?
- What do you need to divide a number by to find 10/20/25/50%?
- What strategies could you use to divide by _____?

Possible sentence stems

- There are _____ lots of _____% in 100%
To find _____% of a number, I need to divide by _____
- The whole amount is worth _____ %.
To find _____%, I need to divide the whole by _____
- If 100% is equal to _____, then _____% is equal to _____

National Curriculum links

- Solve problems involving the calculation of percentages and the use of percentages for comparison

Percentage of an amount – one step

Key learning

- There are two lots of 50% in 100%.

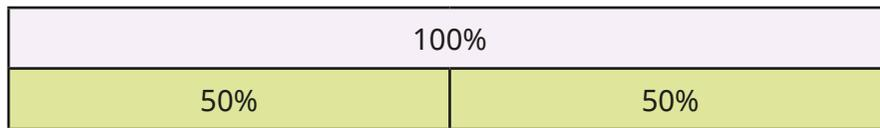

This means that to find 50% of an amount, you divide it by 2

Work out 50% of each number.



- There are four lots of 25% in 100%.

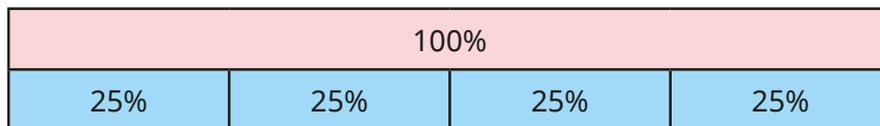

This means that to find 25% of an amount, you divide it by 4

Work out 25% of each number.

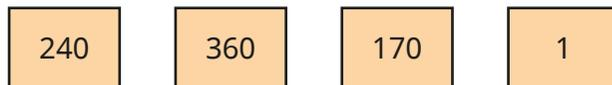

What do you notice about your answers?

Why does this happen?

- Use the bar model to complete the sentences for 10% and 20%.



There are _____ lots of _____% in 100%.

To find _____% of an amount, you divide it by _____

- Work out the percentages.



What do you notice?

- $100 \div 100 = 1$

So to find 1% of an amount, divide it by 100

Find 1% of each number.



Percentage of an amount – one step

Reasoning and problem solving

Tiny is finding percentages of amounts.

To find 10% I divide by 10, so to find 50% I divide by 50



Explain the mistake that Tiny has made.

What do you need to divide by to find 50%?

What percentage would you find if you divided by 50?

2

2%

My amount is greatest, because I started with the greatest amount.

Max
20% of 480

My amount is greatest, because I am finding the greatest percentage.

Eva
50% of 210

I think my amount is greatest.

Alex
25% of 424

Who do you agree with?
Talk about it with a partner.

Alex

Percentage of an amount – multi-step

Notes and guidance

In this small step, children build on the learning of the previous step by finding percentages of amounts that require more than one step.

Using knowledge of how to find 1%, 10%, 20%, 25%, 50%, children find multiples of these amounts. For example, to find 75% they can find 25% and multiply it by 3; to find 60% they can find 10% and multiply it by 6. They then move on to more complex percentages.

Allow children time to explore different ways of making percentages without actually calculating the percentages of amounts, for example 45% can be made from $25\% + 10\% + 10\%$, $5\% \times 9$, $1\% \times 45$, $50\% - 5\%$. Once children recognise that percentages can be made in a range of ways, they apply this to finding a percentage of an amount using the most efficient method.

Things to look out for

- Children often do not explore subtraction as an efficient strategy, particularly subtracting from the whole, for example $95\% = 100\% - 5\%$.
- Children may rely on finding 1% and then multiplying it, rather than considering more efficient methods.

Key questions

- How can you find 1%/10%/20%/25%/50% of a number?
- How can you use 10% to find 30%?
- How can the percentage 36% be made using 1%, 5%, 10%, 20%, 25%, 50% and 100%?
- If you know 1% of an amount, how can you work out 37% of that amount?
- If you know 1% of an amount, how can you work out 99% of that amount?

Possible sentence stems

- _____% is made up of _____%, _____ and _____%.
- _____% of _____ is equal to _____
- If 100% is equal to _____, then _____% is equal to _____
- _____% is equal to _____ lots of _____%.

National Curriculum links

- Solve problems involving the calculation of percentages and the use of percentages for comparison

Percentage of an amount – multi-step

Key learning

- Work out 1% of each number.

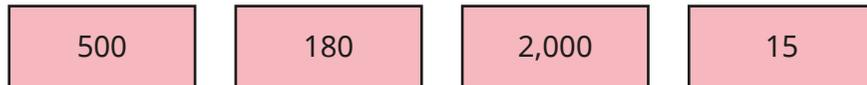

Use your answers to work out the percentages of amounts.



- The bar model shows that 30% is made up of three lots of 10%.

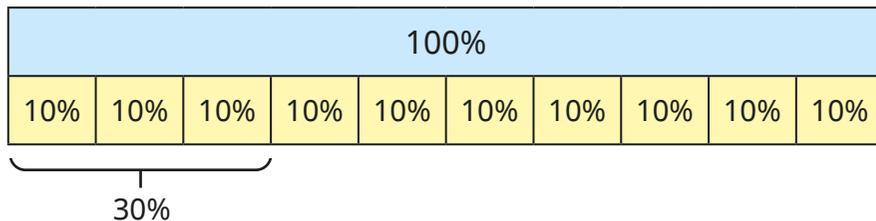

Use the bar model to help you work out the percentages.



- Calculate the percentages.



- Here is a method for finding 11% of 250

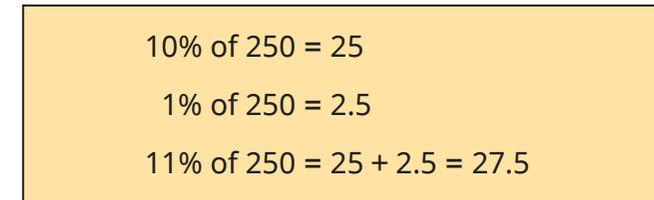

Use this method to work out the percentages.



- Rosie knows that 99% of an amount is 1% less than the full amount, so she finds 1% and takes that away from the total.

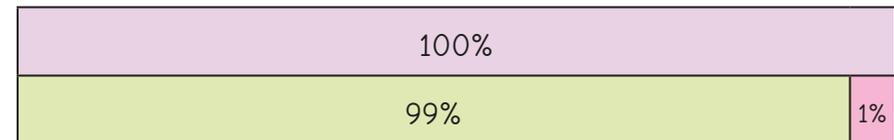

Use this to work out the percentages.

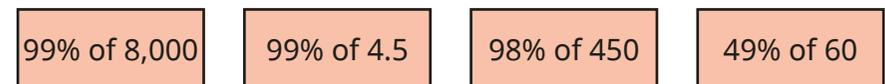

Percentage of an amount – multi-step

Reasoning and problem solving

Dora, Jack, Mo and Rosie were asked to find 90% of a number.

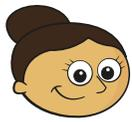

I found 10% and multiplied it by 9

Dora



I found 1% by dividing by 100, then I multiplied my answer by 90

Jack



I worked out $50\% + 10\% + 10\% + 10\% + 10\%$.

Mo

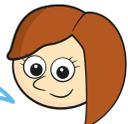

I found 10% and subtracted it from 100%

Rosie

Whose method is correct?

Explain your answer.



All the methods are acceptable ways of finding 90%.

Work out 24% of 3.5 metres.



Give your answer in centimetres and in metres.

Compare methods with a partner.



84 cm, 0.84 m

Work out the percentages of amounts.



45% of 60

60% of 45

27

27

What do you notice?

Does this always happen?



Percentages – missing values

Notes and guidance

For the final small step in this block, children use their understanding of percentages to find the whole number from a given percentage. This links back to the previous step, as children will have to know how many lots of _____% are in 100% and multiply accordingly. For example, if they know 20% of a number, then they multiply that by 5 to work out 100%.

Once confident with simple percentages such as 1%, 10%, 20%, 25% or 50%, children work out percentages such as 12% that cannot be solved in one step. With examples such as these, children recognise that for any percentage, they can find 1% first before multiplying up to 100%. For example, if they know 9% of a number, they divide that by 9 then multiply by 100. Similarly, if they know 30% of a number, they can divide that by 3 and then multiply by 10

Things to look out for

- Children may be confused with two-step solutions, for example saying “30% of a number is 12, so I will multiply 12 by 30”
- Children may use inefficient methods to multiply, for example using the formal method for $\times 10$

Key questions

- If you know _____% of a number, how can you work out the whole?
- How many lots of _____% are there in 100%?
- If you know 23%, how can you find 1%? Once you know 1%, how can you find 100%?
- If you know 40%, how can you find 10%? Once you know 10%, how can you find 100%?
- How can linking percentages to fractions help you to answer this question?

Possible sentence stems

- If _____% of a number is _____, then the whole is _____
- There are _____ lots of _____% in 100%.
- If _____% of a number is _____, then 1% of the number is _____, so 100% is _____

National Curriculum links

- Solve problems involving the calculation of percentages and the use of percentages for comparison

Percentages – missing values

Key learning

- If you know 10% of a number, you can multiply by 10 to find the whole.

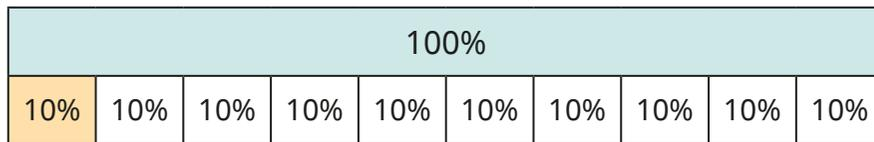

Work out the missing numbers.

- ▶ 10% of _____ = 2.8 ▶ 10% of _____ = 709
- ▶ 10% of _____ = 45p ▶ 10% of _____ = 38 g
- ▶ If 50% of a number is 123, what is the number?
- ▶ If 25% of a number is 45, what is the number?
- ▶ If 20% of a number is 70, what is the number?
- Tom knows that 30% of a number is 210
He then works out the whole by finding 10% first.

$10\% = 210 \div 3 = 70$ $100\% = 70 \times 10 = 700$

Use Tom's method to work out the missing numbers.

- ▶ 30% of _____ = 360 ▶ 70% of _____ = 4.9
- ▶ 90% of _____ = 0.36 kg ▶ 60% of _____ = 92p

- Use the bar models to work out the missing numbers.

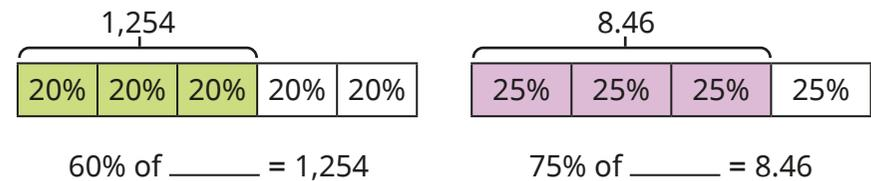

- If you know 1% of a number, you can work out the whole by multiplying by 100
Use this fact to work out the missing numbers.
- ▶ 1% of _____ = 0.06 ▶ 1% of _____ km = 56 m
- ▶ 3% of _____ = 0.27 ▶ 1% of _____ g = 2.9 g
- 12% of a number is 36

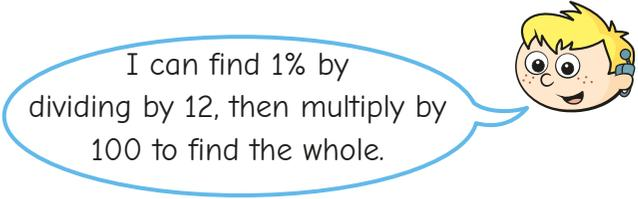

Use Max's method to find the whole.

- Annie is thinking of a number.
15% of her number is 90
What is her number?

Percentages – missing values

Reasoning and problem solving

A bag contains red, blue and yellow balloons.

20% of the balloons in the bag are red.

There are 24 red balloons.

There are three times as many blue balloons as yellow balloons.

How many blue and yellow balloons are there in the bag?



72 blue, 24 yellow

Fill in the missing values to make the statement correct.

25% of = % of 60

Can you find more than one way?



multiple possible answers, e.g.

25% of 60 = 25% of 60

25% of 120 = 50% of 60

Tiny is solving this problem.

5% of = 0.3

I know that there are 20 lots of 5% in 100%, so I will multiply 0.3 by 20 to find the answer.



5% = 0.3
100% = 0.3 × 20 = 6

Do you agree with Tiny?
Explain your answer.



Yes

Spring Block 5

Area, perimeter and volume

Small steps

Step 1

Shapes – same area

Step 2

Area and perimeter

Step 3

Area of a triangle – counting squares

Step 4

Area of a right-angled triangle

Step 5

Area of any triangle

Step 6

Area of a parallelogram

Step 7

Volume – counting cubes

Step 8

Volume of a cuboid



Shapes – same area

Notes and guidance

In this small step, children recap learning from previous years by finding the areas of shapes. It may be useful to remind children about the differences between area and perimeter, which will be covered explicitly in the next step.

Children find the areas of shapes by counting squares and then identify shapes that have the same area. It should become clear to children that shapes can look different but still have the same area. Rectilinear shapes are included here.

Children then explore instances when multiplication can be used to find the areas of shapes. They should begin to identify rectangles that will have the same area by using factor pairs rather than relying on counting squares. They can also use factor pairs to draw rectangles that have the same area.

Things to look out for

- Children may confuse area and perimeter.
- When counting squares, children may miscount or use inefficient strategies.
- Children may not use factor pairs to notice shapes that have the same area or to create shapes with the same area.

Key questions

- How can you find the area of this shape? Is there more than one way?
- Do shapes that have the same area have to look the same?
- How can you use factor pairs to find shapes that would have the same area?
- How would you draw more than one rectangle that has an area of _____ cm^2 ?

Possible sentence stems

- The total number of squares in the rectangle is _____
The area of the rectangle is _____ cm^2
- The length of the rectangle is _____ cm.
The width of the rectangle is _____ cm.
The area of the rectangle is _____ cm^2

National Curriculum links

- Recognise that shapes with the same areas can have different perimeters and vice versa

Shapes – same area

Key learning

- Complete the sentences to describe the rectangle.

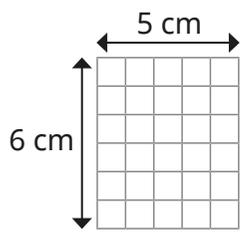

The length of the rectangle is _____ cm.
 The width of the rectangle is _____ cm.
 The total number of squares in the rectangle is _____
 The area of the rectangle is _____ cm²

Use the same method to find the areas of these rectangles.

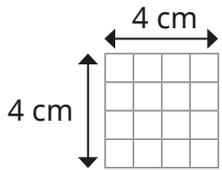

What do you notice?

- Each square represents 1 cm²

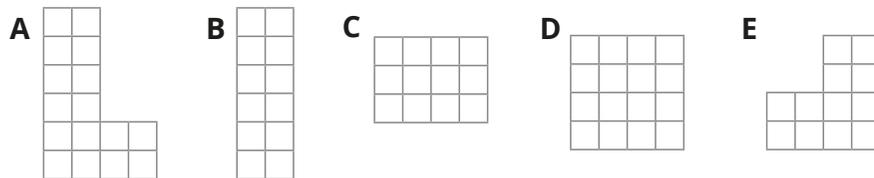

- ▶ Which shapes have an area of 12 cm²?
- ▶ Which shapes have an area of 16 cm²?
- ▶ Why is there more than one representation for each?

- Find the areas of the rectangles.

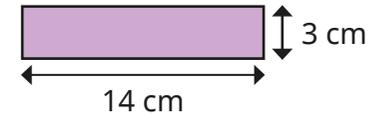
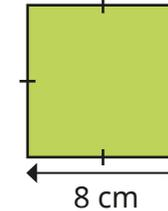
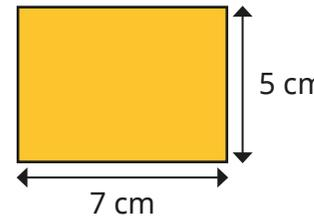

Explain your method to a partner.

- Which two rectangles have the same area?

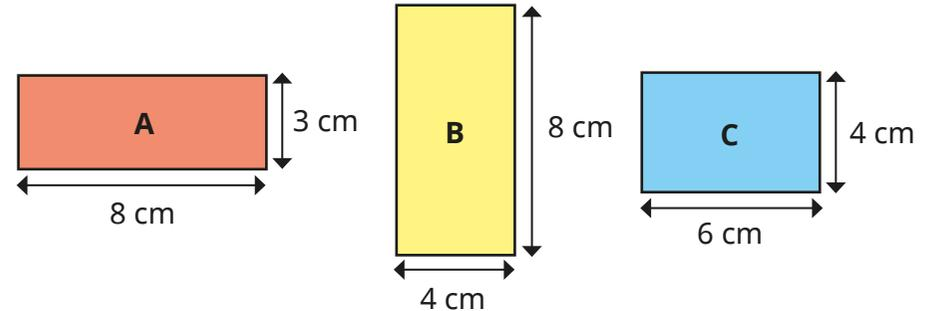

How do you know?

- Draw as many rectangles as possible that have these areas.
 All the side lengths should be whole numbers.
 - ▶ 36 cm²
 - ▶ 16 cm²
 - ▶ 17 cm²
 What do you notice about your last answer?

Shapes – same area

Reasoning and problem solving

These two shapes cannot have the same area, as they look different.

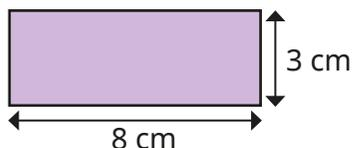
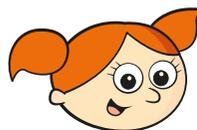

Do you agree with Alex?
Explain your answer.

No

Which rectangle has the greatest area?

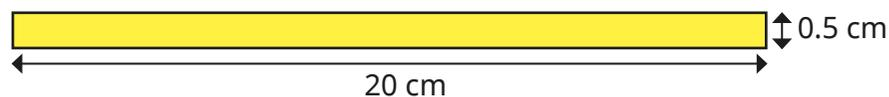
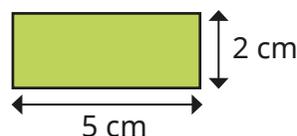

Sketch the next rectangle in the pattern.
What is its area?
How do you know?

All the rectangles have the same area.

10 cm²

Area and perimeter

Notes and guidance

Building on the previous step and reinforcing learning from Year 5, in this small step children find the areas and perimeters of rectangles and rectilinear shapes.

Children explore methods for finding the perimeters and areas of rectangles and rectilinear shapes and compare their efficiency. When finding the area of a rectilinear shape, encourage children to look for the most efficient way to split the shape rather than always splitting it the same way. They should pay close attention when calculating unknown side lengths, and explain how they know whether they need to add or subtract. They can also explore when it may be efficient to find the area of a rectilinear shape by subtracting the missing part from the area of a whole rectangle.

Things to look out for

- Children may confuse area and perimeter.
- When finding the area of a rectilinear shape, children may not split the shape in the most efficient way.
- When calculating the perimeter, children may not use efficient strategies, instead relying on adding lengths in order.
- Children may struggle to work out missing side lengths or forget to do so.

Key questions

- What is perimeter? What is area?
- How can you find the perimeter of the rectangle?
- How can you find the area of the rectangle?
- What is the formula to find the area of a rectangle?
- How can you split the rectilinear shape into rectangles? Is there more than one way?
- How is finding the area/perimeter of a rectilinear shape different to finding the area/perimeter of a rectangle? How is it similar?
- How can you work out the other side lengths?

Possible sentence stems

- The formula to find the area of a rectangle is ...
- To find the perimeter of a rectangle, I ...

National Curriculum links

- Recognise that shapes with the same areas can have different perimeters and vice versa
- Recognise when it is possible to use formulae for area and volume of shapes

Area and perimeter

Key learning

- Find the area and perimeter of each rectangle.

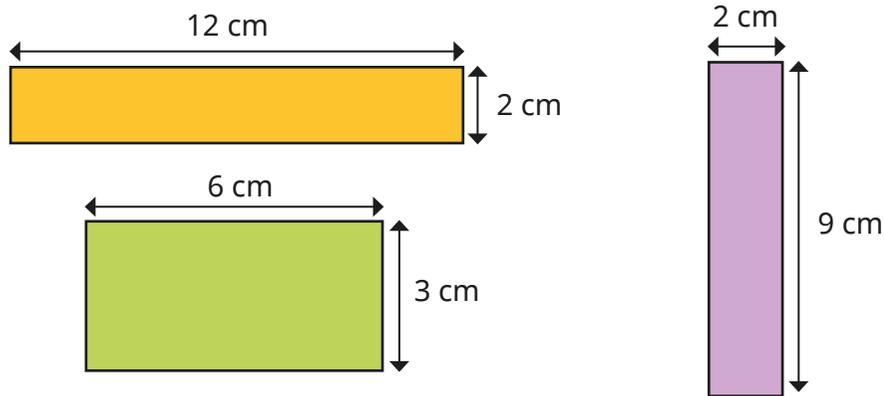

Compare methods with a partner.

- Work out the perimeters of the rectilinear shapes.

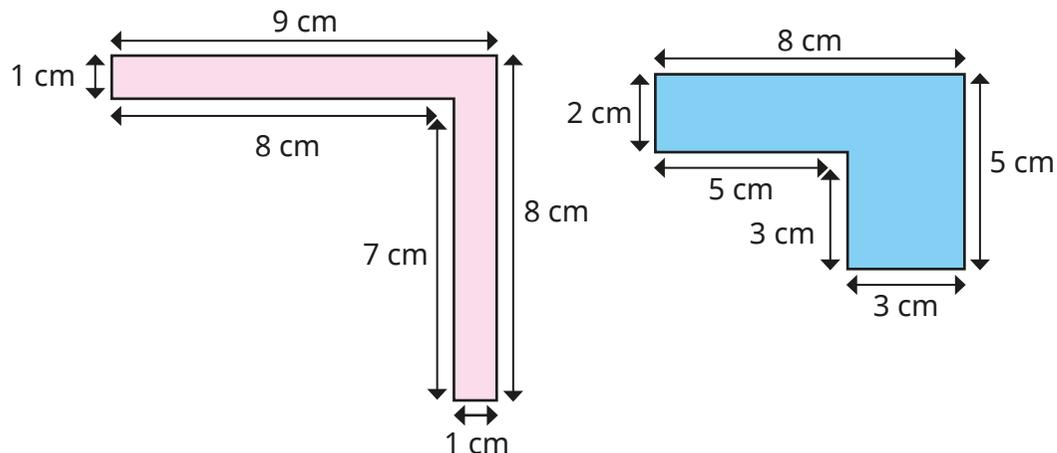

- Both of these rectilinear shapes are made from two rectangles.

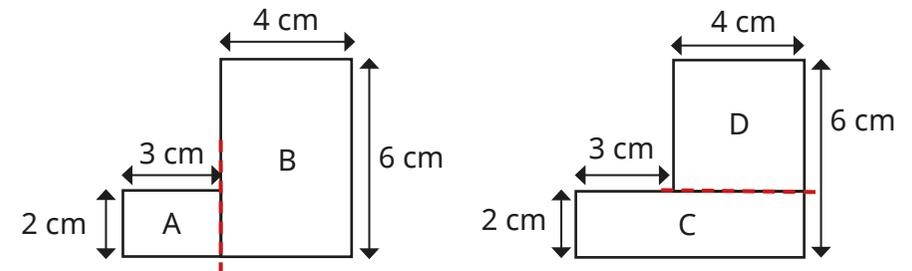

Work out the areas of the rectangles to work out the areas of the rectilinear shapes.

What do you notice?

Why does this happen?

- Find the area and perimeter of each shape.

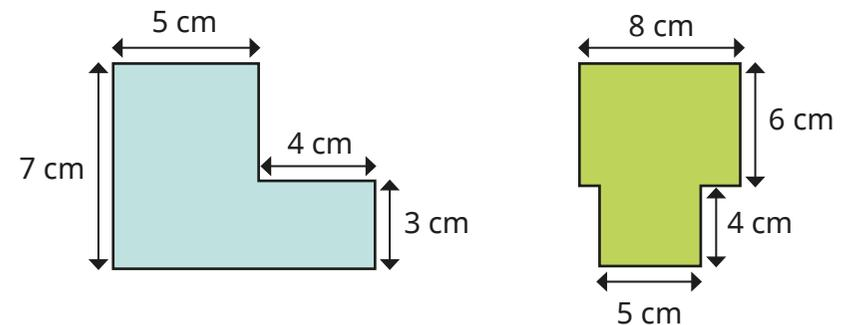

Area and perimeter

Reasoning and problem solving

Tiny is finding the area of this shape.

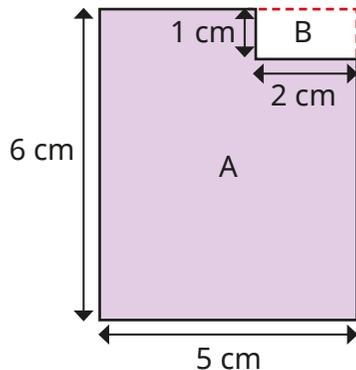

$$\begin{aligned} \text{Area of A} &= 6 \text{ cm} \times 5 \text{ cm} \\ &= 30 \text{ cm}^2 \end{aligned}$$

$$\begin{aligned} \text{Area of B} &= 1 \text{ cm} \times 2 \text{ cm} \\ &= 2 \text{ cm}^2 \end{aligned}$$

$$\text{Total area} = 32 \text{ cm}^2$$



The area is 32 cm^2

Do you agree with Tiny?

Explain your answer.

No

Dora has made two rectilinear shapes using lolly sticks.

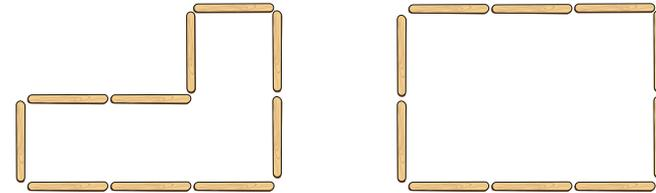

The length of each lolly stick is 10 cm.

Work out the perimeter of each shape.

What do you notice?

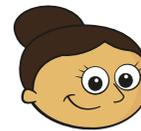

If I cut a rectangle out of the corner of another rectangle, the perimeter of the rectilinear shape will always be the same as the perimeter of the rectangle I started with.

Do you agree with Dora?

Talk about it with a partner.

both 100 cm

Yes

Area of a triangle – counting squares

Notes and guidance

In this small step, children are introduced to finding the area of a triangle by counting squares. They estimated area in Year 5, but may need to be reminded of efficient strategies for calculating and estimating areas of shapes.

Children first find the areas of triangles that require them to only count full and half squares. They can calculate these separately and then combine them to find the area. They then move on to estimating the areas of triangles that involve sections of squares greater and less than half. Children also explore creating their own triangles with a specific area.

Some links are made between the area of a rectangle and the area of a triangle, but the formula is not introduced until the next step.

Things to look out for

- Children may count half squares as full squares.
- Without an efficient method, children may not count squares accurately.
- Children may find it difficult to draw a triangle with a specific area.
- If a triangle is not placed on a line, children may believe it is impossible to estimate its area.

Key questions

- How is finding the area of a triangle similar to finding the area of a rectangle when counting squares? How is it different?
- How will you count the squares accurately?
- Is more or less than half the square shaded?
- Can you see any parts of squares that combine to make approximately one full square?
- How does the area of the rectangle link to the area of a triangle? Why do you think this happens?

Possible sentence stems

- The triangle has _____ full squares.
The triangle has _____ half squares.
The area of the triangle is _____ cm^2
- The approximate area of the triangle is _____ cm^2

National Curriculum links

- Calculate the area of parallelograms and triangles

Area of a triangle – counting squares

Key learning

- Complete the sentences to find the area of the triangles.

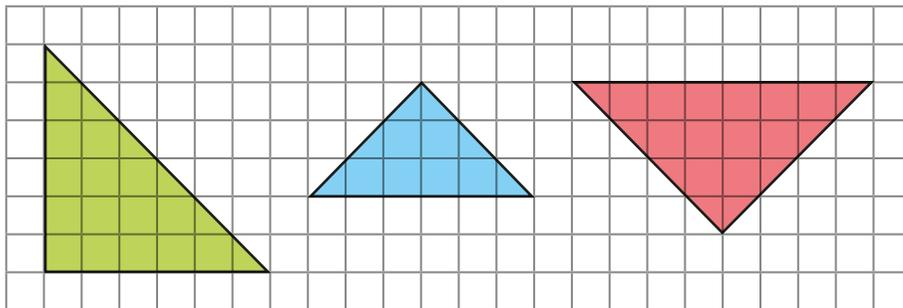

The triangle has _____ full squares.

The triangle has _____ half squares.

_____ + _____ = _____

The total area of the triangle is _____ cm²

- Estimate the areas of the triangles by counting squares.

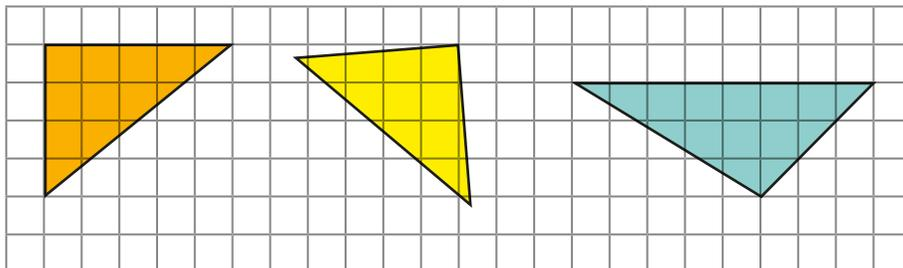

- Draw three different triangles that have an area between 5 cm² and 15 cm²

Label the approximate area of each triangle.

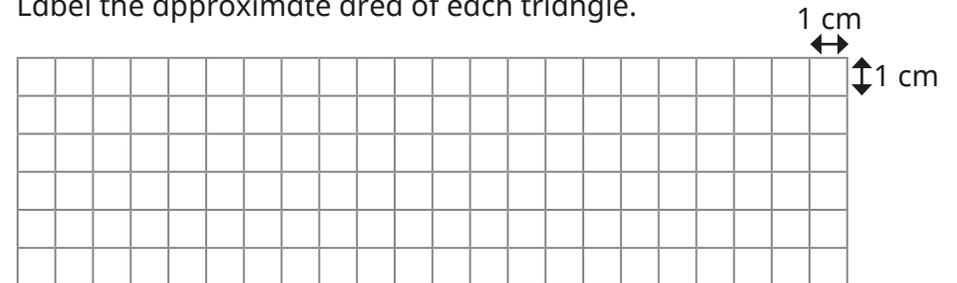

- Work out the area of each shape by counting squares.

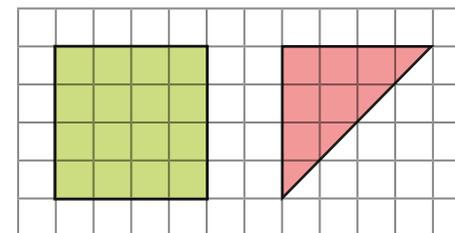

What do you notice about the area of the triangle compared to the area of the square?

Does this always happen?

Draw a rectangle and a triangle to explore the pattern.

Area of a triangle – counting squares

Reasoning and problem solving

Tiny says that the area of the triangle is 15 cm^2

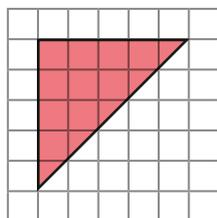

Tiny is incorrect.

Explain what Tiny has done wrong.

Tiny has counted the half squares as full squares.

Part of the triangle has been covered.

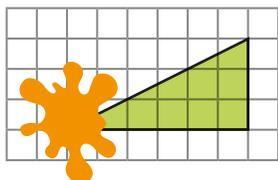

Estimate the area of the whole triangle.

Would your estimate change if the splat was in a different place?

9 cm^2

Huan draws three squares and splits them into six right-angled triangles.

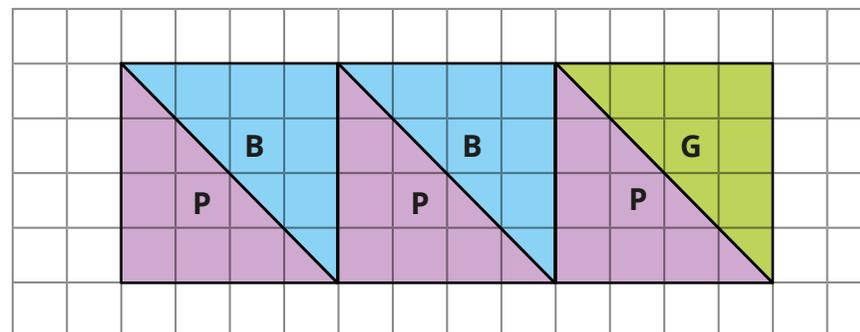

What is the total area of the purple (P) triangles?

What is the total area of the blue (B) triangles?

What is the area of the green (G) triangle?

Compare methods with a partner.

purple: 24 cm^2

blue: 16 cm^2

green: 8 cm^2



Area of a right-angled triangle

Notes and guidance

In this small step, children look in more detail at finding the areas of right-angled triangles.

Children move on from counting squares to identifying and using a formula. They explore the fact that a right-angled triangle with the same length and perpendicular height as a rectangle has an area that is half the area of the rectangle. They then adapt the formula for the area of a rectangle to find the area of a right-angled triangle. Children use the formula $\text{area} = \frac{1}{2} \times \text{base} \times \text{perpendicular height}$ rather than $\frac{1}{2} \times \text{length} \times \text{width}$ in readiness for the next step, where they look at non-right-angled triangles. This vocabulary should be explored and children should be confident identifying the correct parts of the triangle.

Things to look out for

- Children may not identify that a rectangle can be made into two right-angled triangles.
- Children may not be able to identify the base and perpendicular height, choosing the incorrect measurements to multiply.
- Children may not associate multiplying by $\frac{1}{2}$ with dividing by 2

Key questions

- How can you split the rectangle into two right-angled triangles?
- What do you notice about the two triangles?
- What do you notice about finding the area of a rectangle and finding the area of a right-angled triangle?
- What is the formula to find the area of a right-angled triangle?
- What does “perpendicular” mean?
- How do you know which measurement is the base/perpendicular height?

Possible sentence stems

- The area of the right-angled triangle is _____ the area of the rectangle.
- The formula for the area of a triangle is ...

National Curriculum links

- Recognise when it is possible to use formulae for area and volume of shapes
- Calculate the area of parallelograms and triangles

Area of a right-angled triangle

Key learning

- Here is a rectangle and a right-angled triangle.

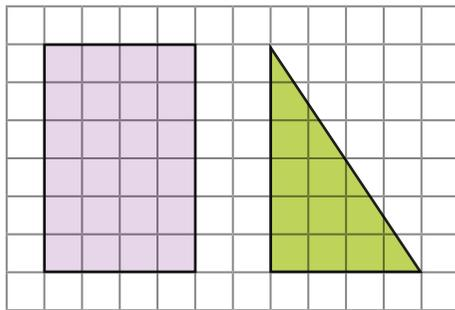

- ▶ What is the area of the rectangle?
- ▶ What is the area of the right-angled triangle?
- ▶ What do you notice?

- Here is a rectangle and a triangle.

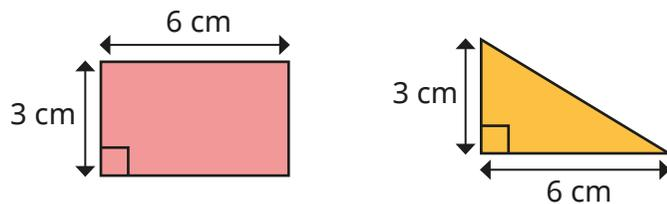

- ▶ What is the area of the rectangle?
- ▶ What is the area of the triangle?
- ▶ How do you work out the area of a right-angled triangle?

- Scott uses the formula to work out the area of this right-angled triangle.

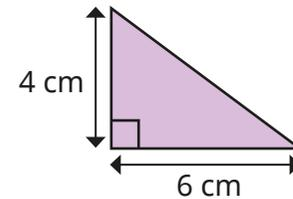

$$\text{area} = \frac{1}{2} \times \text{base} \times \text{perpendicular height}$$

$$\text{area} = \frac{1}{2} \times 6 \times 4 = \frac{1}{2} \times 24 = 12 \text{ cm}^2$$

Use the formula to find the areas of the triangles.

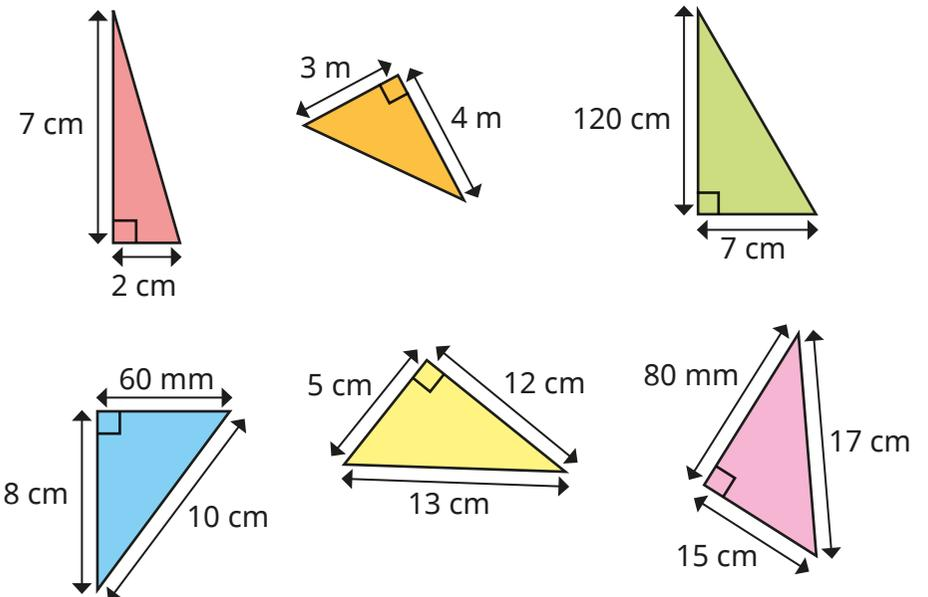

Area of a right-angled triangle

Reasoning and problem solving

Tiny is working out the area of a right-angled triangle.

I only need to know the lengths of any two sides to work out the area of a triangle.



Do you agree with Tiny?
Explain your answer.

No

The area of a right-angled triangle is 54 cm^2

What could the base and height be?

How many solutions can you find?

multiple possible answers, e.g. 18 cm and 6 cm

Calculate the area of the shaded triangle.

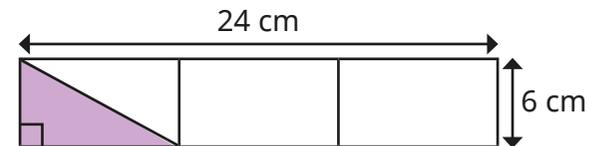

Compare methods with a partner.

24 cm^2

Aisha has placed five right-angled triangles onto a square.

The total area of the square is 36 cm^2

1 cm^2 is not covered by a triangle.

What is the area of the green triangle?

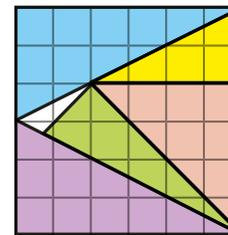

5 cm^2

Area of any triangle

Notes and guidance

In this small step, children extend their knowledge of finding the area of a right-angled triangle to find the area of any triangle.

Children use the same formula as before, but now need to identify that the perpendicular height is not always the length of one of the sides. Initially, they find the areas of triangles where only the base and perpendicular height are given, before looking at triangles where more measurements are given.

Children need to understand that the base is not always at the bottom of a triangle and sometimes there may be more than one possible calculation they could use to find the area.

Things to look out for

- Children may not identify the base and perpendicular height correctly.
- Children may think that the base is always at the bottom of the triangle.
- Children may think that the measurement giving the perpendicular height is always labelled inside the triangle.
- If given more than two measurements, children may multiply the incorrect lengths.

Key questions

- What is the formula for the area of a triangle?
- How do you know which side is the base?
- How do you know what the perpendicular height is?
- How do you know that you are using the correct lengths?
- Is there more than one way to find the area of this triangle?
- Is the base always at the bottom of the triangle?

Possible sentence stems

- The formula for the area of a triangle is ...
- The base is _____ cm.

The perpendicular height is _____ cm.

$$\text{Area} = \frac{\square}{\square} \times \text{_____} \times \text{_____}$$

National Curriculum links

- Recognise when it is possible to use formulae for area and volume of shapes
- Calculate the area of parallelograms and triangles

Area of any triangle

Key learning

- Work out the areas of shapes A, B and C.

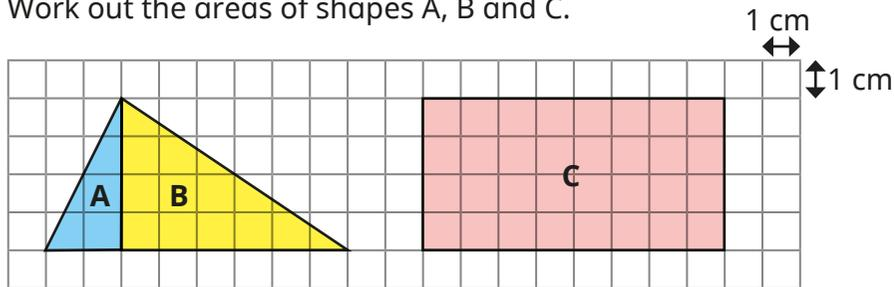

- ▶ What is the total area of the scalene triangle formed by A and B?
- ▶ Compare this area to the area of rectangle C.

What do you notice?

Does this always happen?

- Here is a triangle.

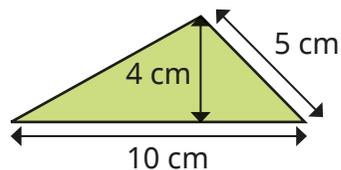

- ▶ What is the length of the base of the triangle?
- ▶ What is the perpendicular height of the triangle?
- ▶ Use the formula $\text{area} = \frac{1}{2} \times \text{base} \times \text{perpendicular height}$ to work out the area of the triangle.

- Work out the areas of the triangles.

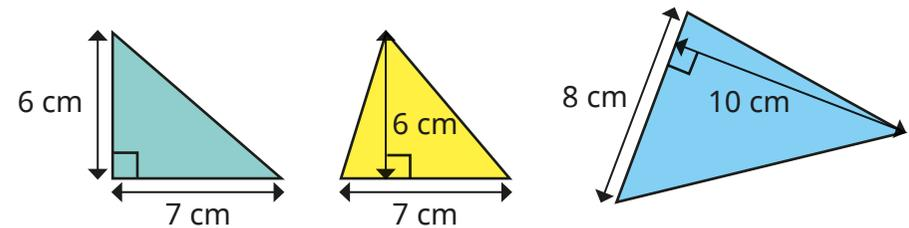

What is the same and what is different about the first two triangles?

- Find the area of each triangle.

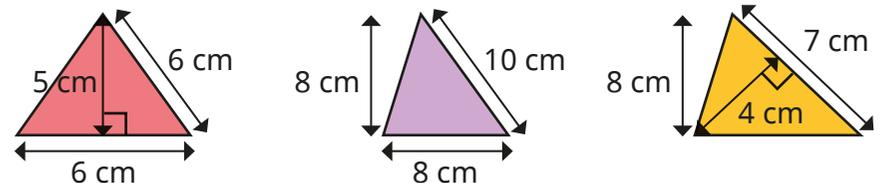

- Calculate the area of each shape.

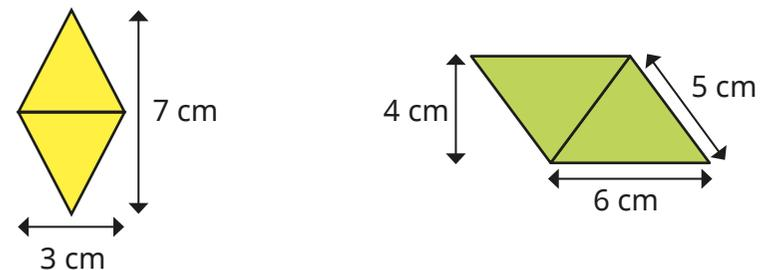

Area of any triangle

Reasoning and problem solving

Tiny is finding the area of this triangle.

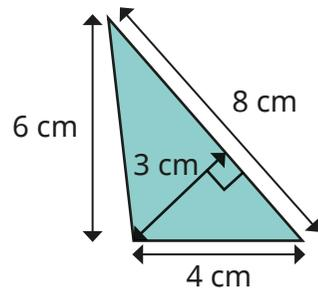

I need to multiply all the lengths, then divide by 2

Explain why Tiny is incorrect.

Work out the area of the triangle.

Can you find more than one way to do it?

12 cm²

This shape is made up of three identical triangles.

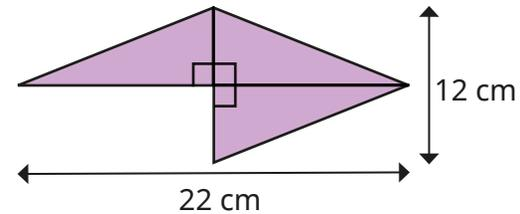

What is the area of the shape?

99 cm²

Here is a flag.

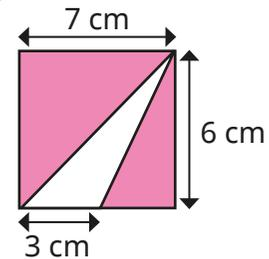

Find the area of the flag that is white.

Is there more than one way to find the answer?

9 cm²

Area of a parallelogram

Notes and guidance

In this small step, children explore the area of a parallelogram, identifying and using a formula.

Children look at the properties of a parallelogram and compare to a rectangle. Using the “cut-and-move method”, they explore how the parts of the parallelogram can be rearranged to make a rectangle in which the length and width correspond to the base and perpendicular height of the parallelogram. Through this, they recognise that the area of a parallelogram can be found by using the formula $\text{area} = \text{base} \times \text{perpendicular height}$.

As they did for triangles, children need to be able to identify the base and perpendicular height when given more than the required measurements. This needs to be carefully modelled so that children do not believe that $\text{area} = l \times w$. It may be useful to compare all the formulas they know for finding the areas of shapes.

Things to look out for

- When finding the area of a parallelogram, children may try to use the formula for finding the area of a rectangle or a triangle.
- Children may struggle to identify the base and perpendicular height.

Key questions

- How could you change the parallelogram into a rectangle? How will this help you to find the area?
- How can you count the squares accurately to find the area?
- How do you know you have found the base/perpendicular height?
- What is the formula for finding the area of a parallelogram?
- When you have different units, what is your first step?

Possible sentence stems

- The base of the parallelogram is _____ cm.
The perpendicular height of the parallelogram is _____ cm.
The area of the parallelogram is _____ \times _____ = _____ cm^2

National Curriculum links

- Recognise when it is possible to use formulae for area and volume of shapes
- Calculate the area of parallelograms and triangles

Area of a parallelogram

Key learning

- Here is a parallelogram.

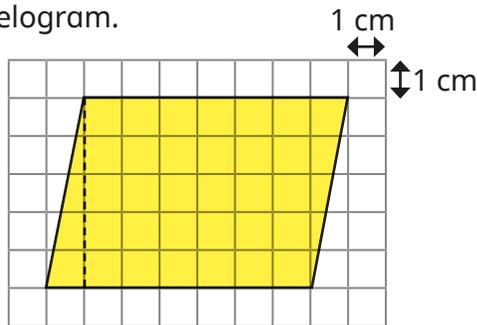

- ▶ Copy the parallelogram onto centimetre squared paper.

Estimate its area by counting squares.

- ▶ Now cut along the dotted line.

Move the triangle to make a rectangle.

What is the area of the rectangle?

What do you notice?

- Work out the areas of the parallelograms.

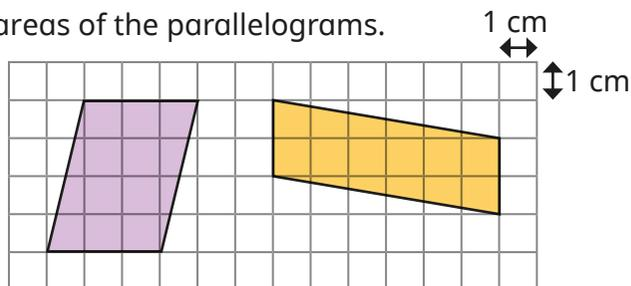

Explain your method to a partner.

- Annie has worked out the area of this parallelogram.

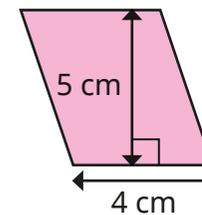

$$\begin{aligned} \text{area} &= \text{base} \times \text{perpendicular height} \\ &= 4 \text{ cm} \times 5 \text{ cm} \\ &= 20 \text{ cm}^2 \end{aligned}$$

Use Annie's method to find the areas of the parallelograms.

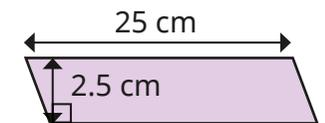
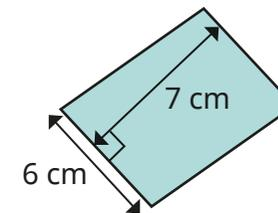
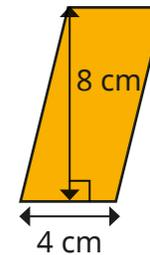

- Label the base b and perpendicular height h on each parallelogram. Then find the area of each shape.

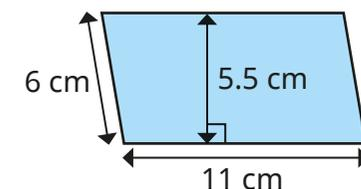
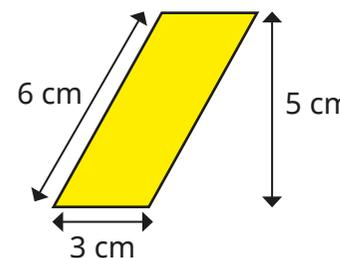

Area of a parallelogram

Reasoning and problem solving

These parallelograms each have an area of 40 cm^2

Find the perpendicular height of each shape.

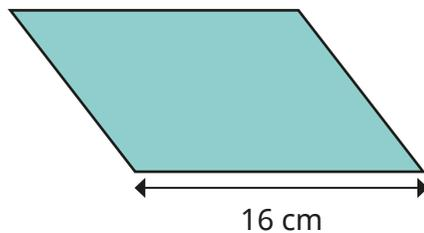
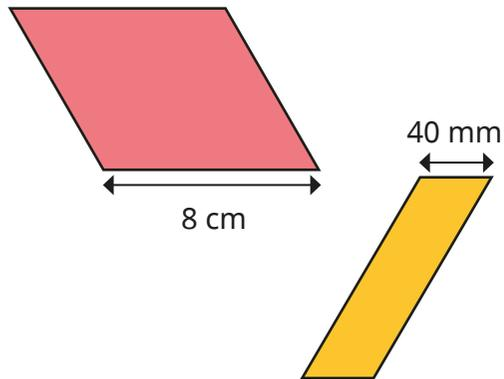

- 5 cm
- 10 cm
- 2.5 cm

All the parallelograms have the same area.

Find the total area of the shaded parallelograms.

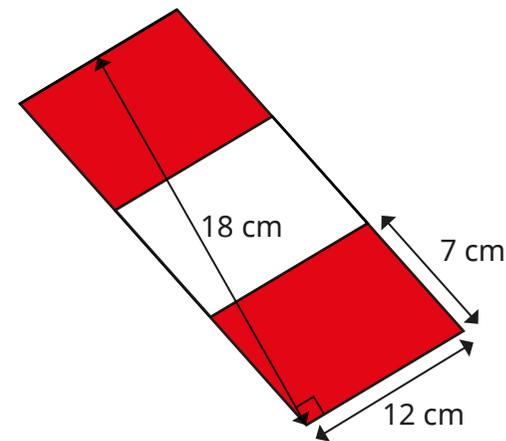

- 144 cm^2

- 7 cm

Which measurement is not needed?

Find more than one method to work out the answer.

Which was more efficient?

Volume – counting cubes

Notes and guidance

In Year 5, children began to explore volume as the amount of space that a solid object takes up. They started by counting cubes, before being introduced to cubic centimetres (cm^3) as a unit of measure for volume. This learning is recapped at the beginning of this small step.

Children then explore shapes where they can find the volume by multiplying the volume of a single layer by the number of equal layers. This can include cuboids and other prisms. Encourage children to explore the relationship between the total volume of a cuboid and its length, width and height, although there is no need to explicitly introduce the formula for finding the volume of a cuboid, as this will be covered in more detail in the next step.

Things to look out for

- Children may believe that shapes that look different visually must have different volumes.
- Children may ignore cubes that cannot be “seen” in an image, so it is important to discuss the possibility of hidden cubes and how children might know for certain that more cubes exist even if they cannot see them.

Key questions

- What is volume?
- How is volume different from area?
- How can you count the number of cubes efficiently?
- If each cube has a volume of 1 cubic centimetre (cm^3), what is the volume of the shape?
- How many cubes are there in this layer? How many equal layers are there? So how can you find the volume?
- What is the length/width/depth of this cuboid?

Possible sentence stems

- The volume of the shape is _____ cubes.
- The volume of the shape is _____ cm^3
- There are _____ cubes in each layer and _____ equal layers, so the volume is _____ cubes.

National Curriculum links

- Calculate, estimate and compare volume of cubes and cuboids using standard units, including cubic centimetres (cm^3) and cubic metres (m^3), and extending to other units

Volume – counting cubes

Key learning

- Using 12 cubes, how many different shapes can you make?



- How many cubes are used to make each shape?

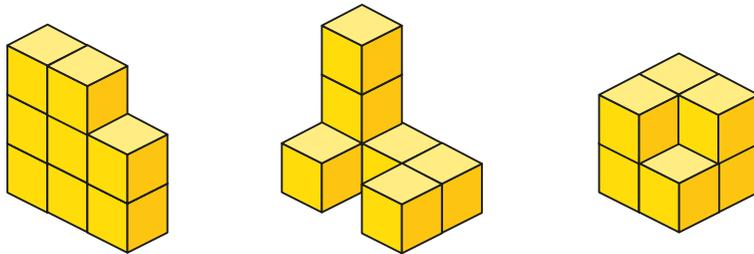

- Brett makes this shape using cubes.

What is the volume of the shape in cubes?

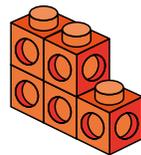

Mo makes an identical shape and attaches the shapes together like this.

What is the volume of the shape in cubes?

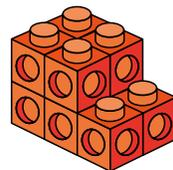

What do you notice?

- Each shape is made using centimetre cubes.
Work out the volume of each shape in cm^3

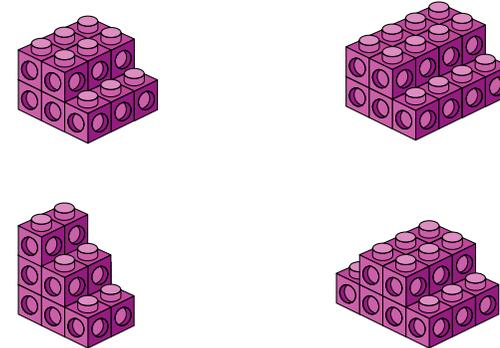

What is the quickest way of finding the volumes?

- Each cuboid is made using centimetre cubes.
Find the volumes of the cuboids.

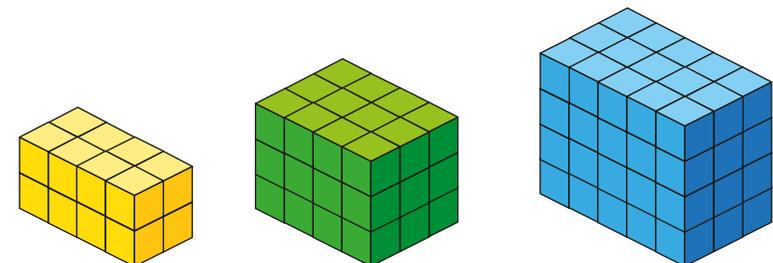

Volume – counting cubes

Reasoning and problem solving

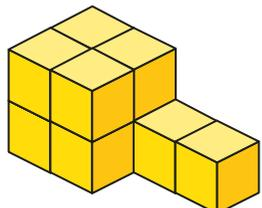

I only need 8 cubes to make this shape.

Do you agree with Tiny?
Explain your reasons.

No

Make a cuboid using 24 cubes.

What are the dimensions of your cuboid?

How many different cuboids can you make with this number of cubes?

multiple possible answers, e.g. 6 cubes, 2 cubes and 2 cubes

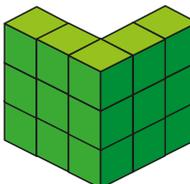

What could the volume of this shape be?

Compare answers with a partner.

between 15 and 23 cubes

Dani makes this cuboid.

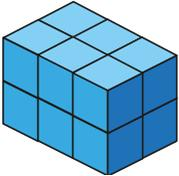

She makes another cuboid by increasing the height, width and depth by 1 cube.

What is the difference in the volumes of the cuboids?

24 cubes

Volume of a cuboid

Notes and guidance

In this small step, children move on from counting cubes to finding the volumes of cuboids using multiplication and applying a formula.

Children discover that they can use multiplication to find the number of cubes in one “layer” of the shape and then multiply this by the number of layers to find the total volume. This will help children identify the formula: volume of cuboid = length \times width \times height. They should recognise that the formula works whichever way they look at the cuboid and what they think of as a “layer”.

Once children understand the formula, encourage them to find the most efficient method to calculate the volume using the associative law of multiplication.

Things to look out for

- Children may think that it is impossible to find the volume without cubes.
- Children may think that they must always multiply $l \times w \times h$ in that order, which may not always be the most efficient calculation.
- When finding the volumes of cubes, children may think that they need more than one measurement.

Key questions

- What is volume?
- How many cubes are there in one layer? How do you know?
- How do you find the total volume of the cuboid?
- What is the formula to find the volume of a cuboid?
- What is the same and what is different about area and volume?
- What is the most efficient order to multiply the three numbers together?

Possible sentence stems

- There are _____ cubes in each layer.
There are _____ layers.
The volume of the cuboid is _____
- The length is _____. The width is _____. The height is _____.
The volume of the cuboid is _____ \times _____ \times _____ = _____

National Curriculum links

- Calculate, estimate and compare volume of cubes and cuboids using standard units, including cubic centimetres (cm^3) and cubic metres (m^3), and extending to other units

Volume of a cuboid

Key learning

- The cuboid is made using centimetre cubes.
 - ▶ What is the volume of the cuboid?
 - ▶ What is the length, width and height of the cuboid?
 - ▶ Find the product of the length, width and height.

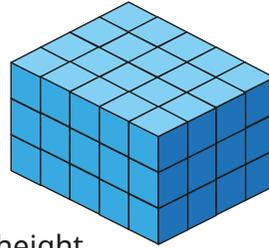

What do you notice?

- Here is the formula for the volume of a cuboid.

$$\text{volume} = \text{length} \times \text{width} \times \text{height}$$

Use the formula to find the volumes of the cuboids.

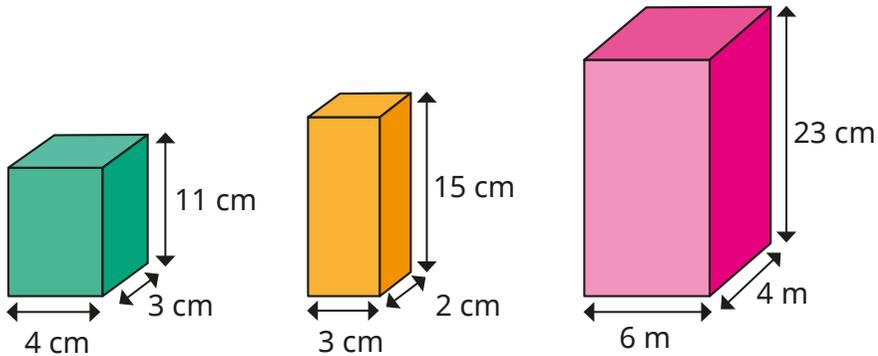

Does it matter in which order you multiply the numbers?

- Find the volumes of the cuboids.

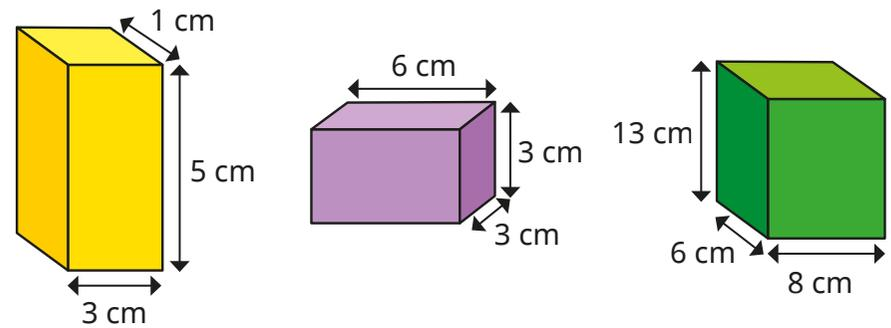

- Find the volumes of the cubes.

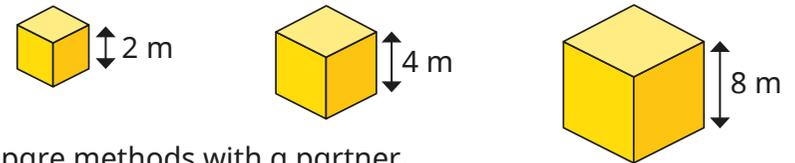

Compare methods with a partner.

- Find the volumes of the cuboids.

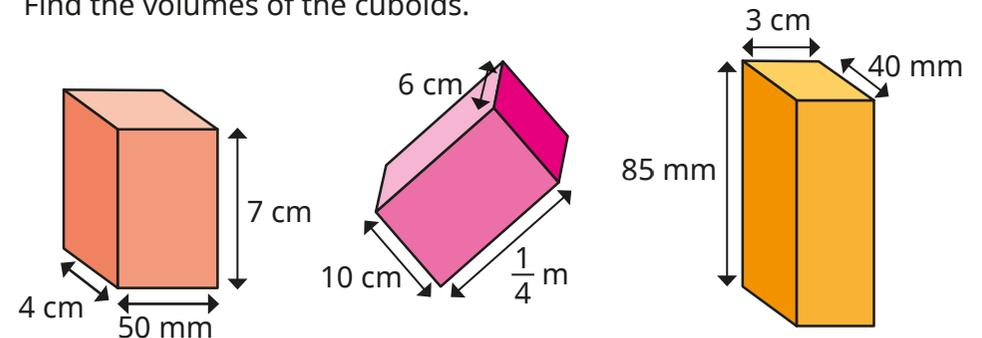

Volume of a cuboid

Reasoning and problem solving

Here is a cube.

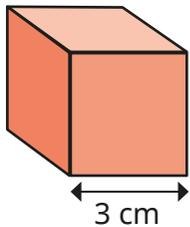

I cannot work out the volume of the cube, because I do not know its width or height.

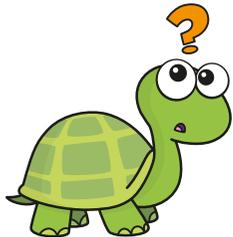

Do you agree with Tiny?

Explain your answer.

No

Which cuboid has the greater volume?

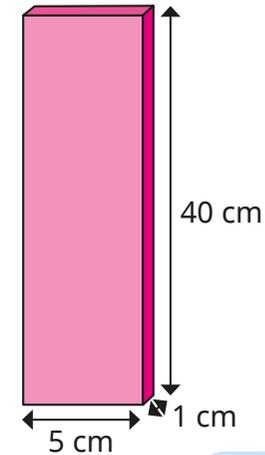
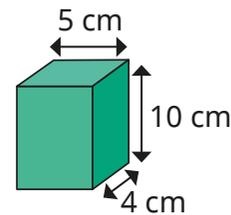

Both cuboids have the same volume: 200 cm^3

Explain how you know.

Calculate the volume of the compound shape.

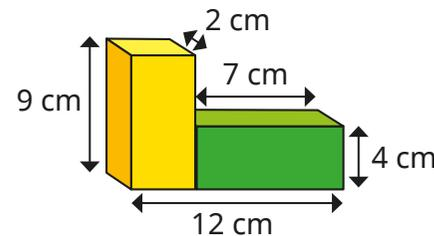

146 cm^3

Spring Block 6

Statistics

Small steps

Step 1

Line graphs

Step 2

Dual bar charts

Step 3

Read and interpret pie charts

Step 4

Pie charts with percentages

Step 5

Draw pie charts

Step 6

The mean

Line graphs

Notes and guidance

In Year 5, children focused on drawing, reading and interpreting simple line graphs. In this small step, they revisit that learning and progress to looking at more complex graphs, including ones with more than one line.

Children start by looking at simple line graphs and the information that can be gathered from them. They should recognise that they can only read off approximate values for data that lies between two marked points, which is why a dashed line is used. They then draw line graphs using given information. When doing this, it is important to discuss what each axis will represent, drawing children's attention to the fact that time is usually shown on the horizontal axis. When they are drawing line graphs, support children in choosing appropriate scales based on the numbers given.

Children also answer problems involving line graphs. They should be able to infer what has happened in a given situation based on the information provided in the line graph.

Things to look out for

- When drawing their own line graphs, children may need support to choose appropriate scales.
- When there is more than one line on a graph, children may use the wrong line.

Key questions

- How do you read information from a line graph?
- What does each axis represent?
- What is the smallest value in the data? What is the greatest?
- What intervals would be appropriate for this line graph?
- What does this line graph tell you?
- What does the direction of the line tell you about what happened?
- How can two sets of data be recorded on the same line graph?

Possible sentence stems

- The horizontal axis shows _____
The vertical axis shows _____
- At _____, the graph reads _____
At _____, the graph reads _____
The difference between the two points is _____

National Curriculum links

- Interpret and construct pie charts and line graphs and use these to solve problems

Line graphs

Key learning

- Discuss with a partner what is the same and what is different about the line graphs.

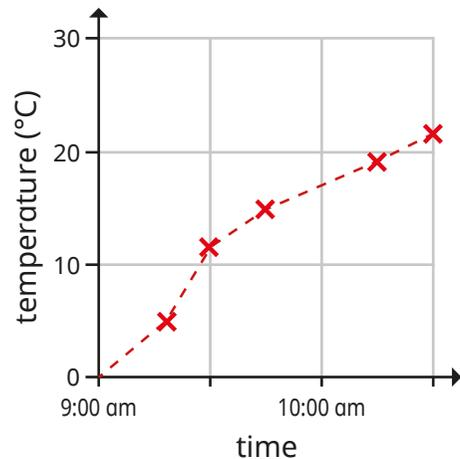
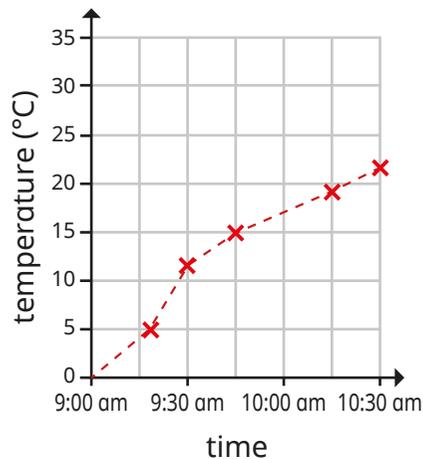

- ▶ What is the temperature at 9:45 am?
- ▶ At what time was the temperature approximately 12 °C?

- The table shows the height a rocket reached between 0 and 60 seconds.

Time (seconds)	0	10	20	30	40	50	60
Height (metres)	0	8	15	25	37	50	70

Draw a line graph to represent the information.

- The graph shows water consumption over two days. The water consumption was recorded every 2 hours.

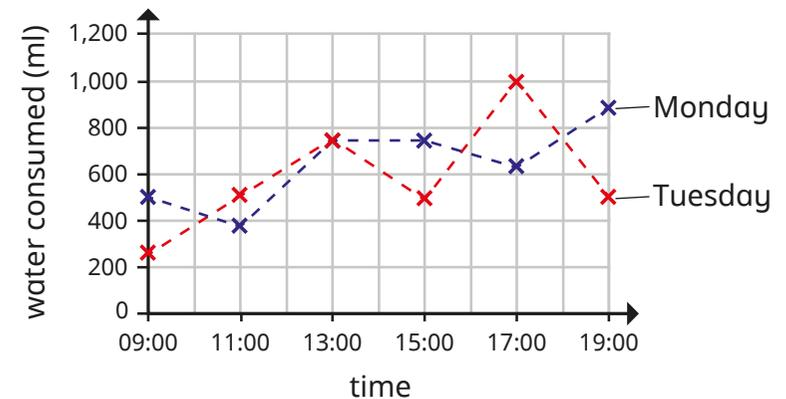

- ▶ At what times was the recorded amount of water consumed on Monday and Tuesday the same?
- ▶ Was more water consumed at 5:00 pm on Monday or Tuesday?

Approximately how much more?

- The table shows the populations in the UK and Australia from 1995 to 2020

	1995	2000	2005	2010	2015	2020
UK	58,000,000	58,900,000	60,300,000	63,300,000	65,400,000	67,900,000
Australia	18,000,000	19,000,000	20,200,000	22,100,000	23,800,000	25,500,000

Draw a line graph to represent the information.

Line graphs

Reasoning and problem solving

This graph shows the distance travelled by a car.
The car stops between 25 and 40 minutes.
Tiny has added the red line to show the car stopped.

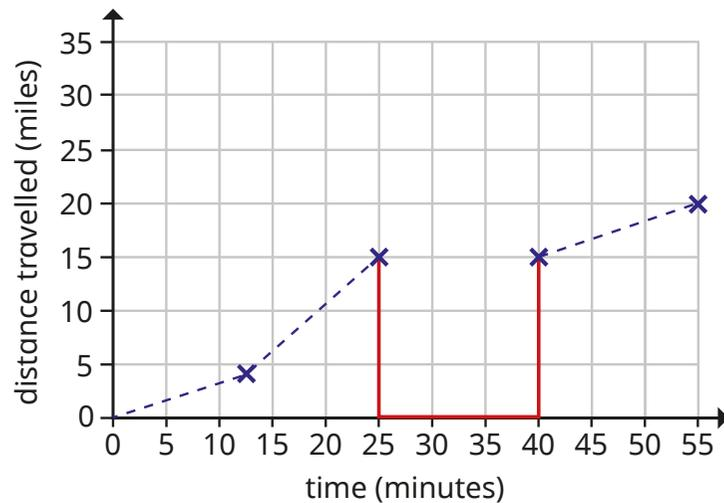

Do you agree with Tiny?
Explain your answer.



No

The graph shows some of Dr Lee's journeys.

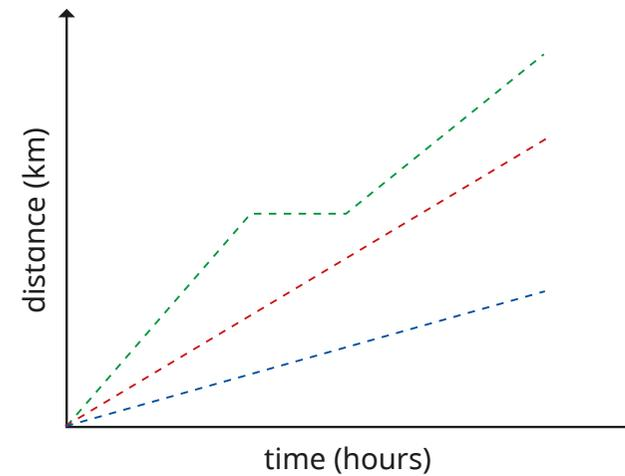

What is the same and what is different about the journeys?

What might have happened during the green journey?



multiple possible answers, e.g.

All the journeys took the same length of time.

During the green journey, Dr Lee might have stopped for a rest.

Dual bar charts

Notes and guidance

In this small step, children build on learning from earlier in the key stage as they explore dual bar charts, looking at the different information that can be seen from them, and discussing the similarities and differences when compared to a single bar chart. In particular, children should recognise the importance of a key to ensure that the bar charts can be interpreted.

It is useful to begin with a simple dual bar chart showing discrete data with small whole numbers, allowing children to explore a range of questions such as the total and difference between various amounts. This is a good opportunity to revisit reading scales and estimating from number lines.

The focus of this step is interpretation, but children could also explore drawing dual bar charts.

Things to look out for

- Children may only read one of each of the pairs of bars.
- Children may combine the pairs of bars and find a total, rather than considering them separately.
- Support may be needed to estimate from scales.

Key questions

- How is a dual bar chart different from a single bar chart?
- What information does this dual bar chart give?
- What is different about what the two bars show?
- How do you know which bar shows which information?
- What questions can be asked about this chart?
- What is the difference between _____ and _____?
- How much is _____ and _____ in total?

Possible sentence stems

- The first bar represents _____
The second bar represents _____
- The difference between _____ and _____ is _____
- The bar is closer to _____ than _____, so I estimate that the value is _____

National Curriculum links

- Interpret and present discrete and continuous data using appropriate graphical methods, including bar charts and time graphs (Year 4)

Dual bar charts

Key learning

- Five children play two games.

Their scores for each game are recorded on a dual bar chart.

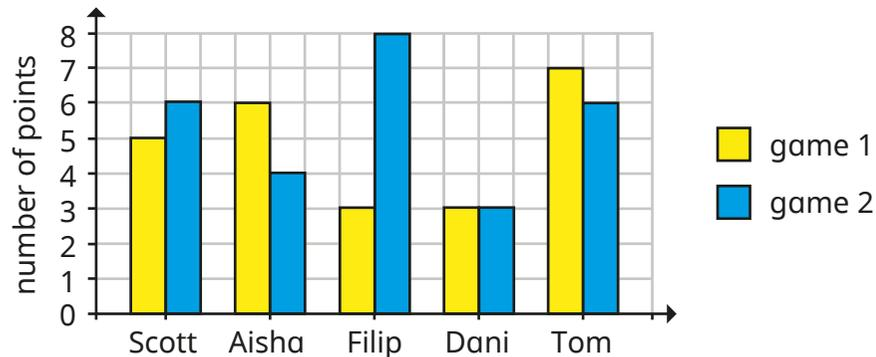

- ▶ Who scored the most points in game 1?
- ▶ Who scored the fewest points in game 2?
- ▶ Who scored the most points altogether in both games?
- ▶ How many children got a higher score on their second game?
- ▶ Which child scored the same on their first and second games?
- ▶ How many more points did Filip score on his second game than his first game?
- ▶ What is the difference between the total points scored in games 1 and 2?

What else can you find out?

- Years 2 to 6 are raising money for charity.

The amount each year group raised in September and October is recorded in the dual bar chart.

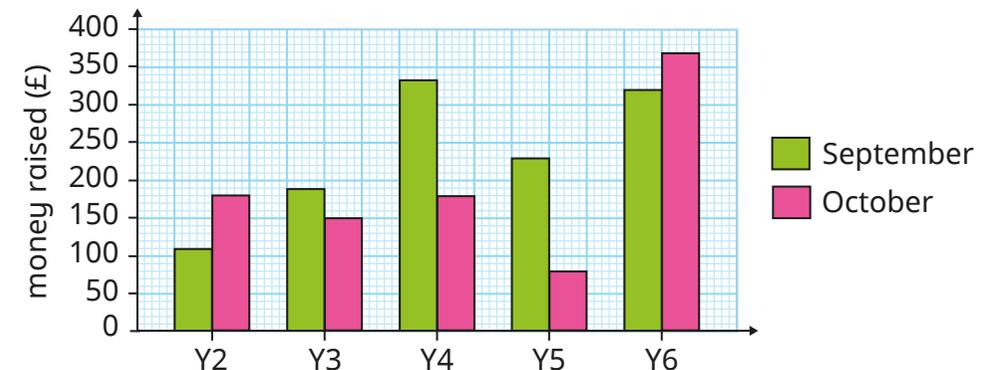

- ▶ How much money was raised in September?
How much was raised in October?
- ▶ Estimate how much more money Year 4 raised than Year 5 in October.
- ▶ Which year group has raised the most money so far?
- ▶ How much money was raised altogether in September and October?
- ▶ How much money in total have all five classes raised so far?

What else can you find out?

Dual bar charts

Reasoning and problem solving

The bar chart shows the number of goals scored by some teams in two games.

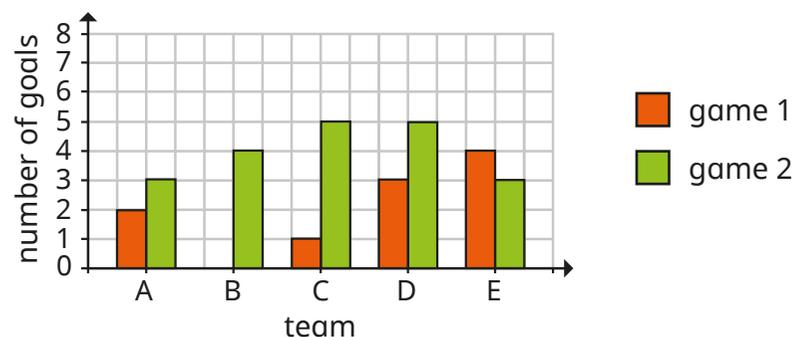

Tiny wants to work out whether each team scored more goals in game 1 or game 2



I need to create a table first to show how many goals they scored in each game.

Do you agree with Tiny?

Explain your answer.

No

The bar chart shows the average temperature in a UK city.

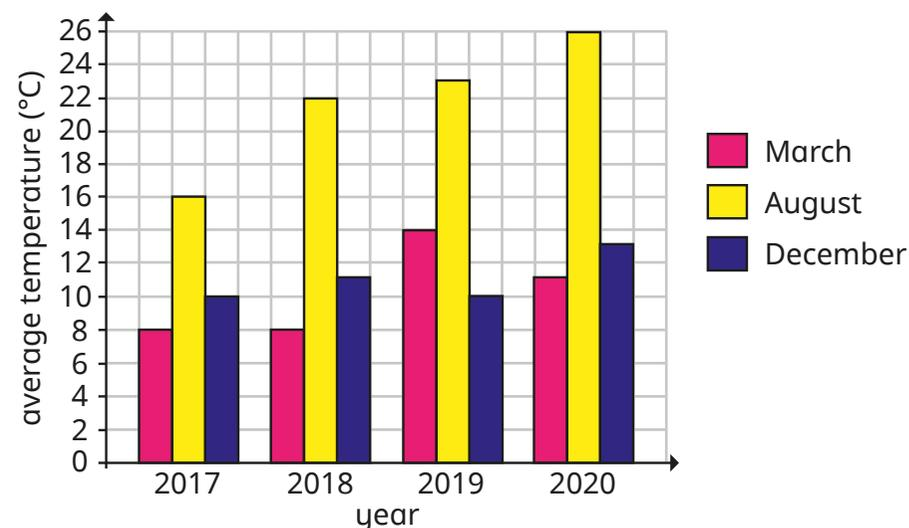

Summarise what the chart tells you.

What questions could you ask a partner about this chart?

Compare answers as a class.

Read and interpret pie charts

Notes and guidance

In this small step, children are introduced to pie charts for the first time. Discuss with children why a pie chart is a useful way to represent data. They should realise that a pie chart quickly and easily shows information as part of the whole. Discuss the fact that bar charts may show the numbers of most/least popular items quickly, whereas pie charts show something as more/less than a half/quarter etc. of the total.

Children first look at simple pie charts to identify the greatest/least amounts. They then move on to using the total number represented by a pie chart to work out what each equal part is worth. Finally, given the value of one part, children work out the total and/or the values of other parts of the pie chart.

Things to look out for

- Children may need a reminder of how to work out fractions of amounts.
- Children may confuse the total number with the value of one part.
- Children may think that because a sector is larger in one pie chart than another that it must represent a greater amount.

Key questions

- What does the pie chart show?
- What does each section of the pie chart show?
- Which of the choices was the most popular? How do you know?
- If you know the total, how can you work out the value of one part?
- If you know the value of one part, how can you work out the total number?
- How is a pie chart different from a bar chart?

Possible sentence stems

- There are _____ equal parts altogether.
The total is _____, so each equal part is worth _____
- One part is worth _____
There are _____ equal parts altogether, so the total is equal to _____

National Curriculum links

- Interpret and construct pie charts and line graphs and use these to solve problems

Read and interpret pie charts

Key learning

- Some children in a class were asked to name their favourite sport. The results are shown in the pie chart.

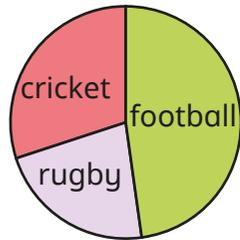

Write **more** or **less** to complete the sentences.

- _____ than half of the class have cricket as their favourite sport.
- _____ than a quarter of the class have football as their favourite sport.

Discuss with a partner what other sentences you can write about the information in the pie chart.

- The pie chart shows how 600 children travel to school.

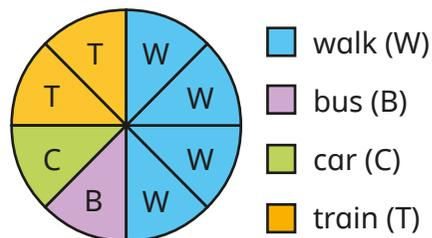

Work out how many children use each method to travel to school.

- Mo asked 180 people to name their favourite flavour of crisps.

The results are shown in the pie chart.

- How many people chose ready salted?
- How many people chose a flavour other than salt and vinegar?
- How many more people chose salt and vinegar than cheese and onion?

What other questions can you ask?

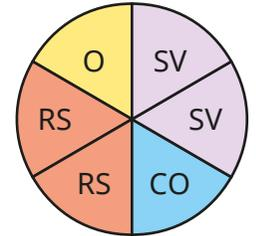

- salt and vinegar (SV)
- cheese and onion (CO)
- ready salted (RS)
- other (O)

- In a survey, people were asked to name their favourite season of the year.

The results are shown in the pie chart.

48 people said that summer was their favourite season.

- How many people took part in the survey?
- How many people said that spring was their favourite season?

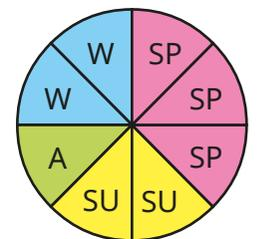

- spring (SP)
- summer (SU)
- autumn (A)
- winter (W)

Read and interpret pie charts

Reasoning and problem solving

200 people were asked to name their favourite colour.

The pie chart shows the results.

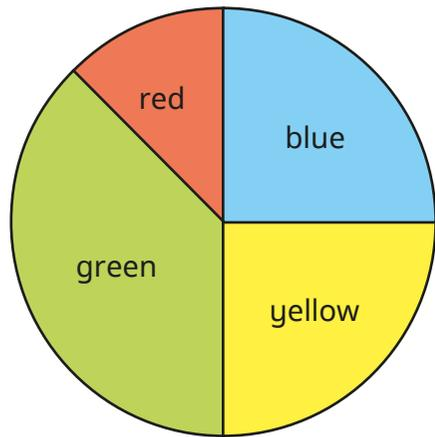

50

Approximately how many more people chose green as their favourite colour than chose red?

How did you work it out?

The pie charts show the favourite colours of the children in two classes.

class 1

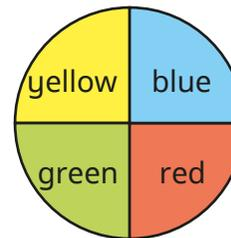

class 2

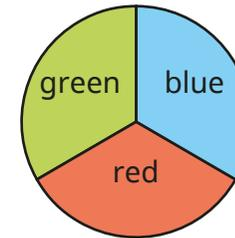

No

More children chose blue in class 2 than in class 1, because the blue part is bigger.



Do you agree with Tiny?

Explain your answer.

Pie charts with percentages

Notes and guidance

This small step revises children's understanding of percentages, in the context of pie charts.

Children need to know that a whole pie chart represents 100% of the data, so one half represents 50%, one quarter represents 25% and so on. It may also be useful to revisit efficient strategies for finding multiples of 10%, 20% and 25%.

Children look at pie charts where the total number is not given, and they need to work out the total from a given percentage. They can then work out the value of the remaining sections, using either the total or proportional reasoning (for example, knowing 40% must be 8 times the size of 5%).

Things to look out for

- Children may not use the most efficient strategy for working out the percentage of an amount.
- Children may assume two pie charts alongside each other represent the same amount.
- When given a part and asked to find the whole, children may not work backwards and instead continue to find a percentage of the amount given.

Key questions

- What percentage does the whole pie chart represent?
- What percentage does half/quarter of the pie chart represent?
- What percentages of an amount can you work out easily?
- How do you work out 10% of an amount? How does this help you to work out other percentages?
- If you know 10%/20%/25%, how can you work out the total?

Possible sentence stems

- If _____% is worth _____, then I can multiply/divide it by _____ to find _____%.
- If the total is _____, then the part representing _____% is worth _____
- If the part representing _____% is worth _____, then the total is _____

National Curriculum links

- Interpret and construct pie charts and line graphs and use these to solve problems

Pie charts with percentages

Key learning

- 150 children were asked to name their favourite flavour of ice cream.

The results are shown in the pie chart.

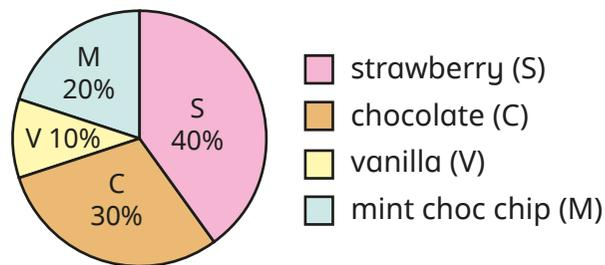

How many children chose each flavour of ice cream?

- 200 children in Key Stage 2 chose an after-school activity.

The pie chart shows the results.

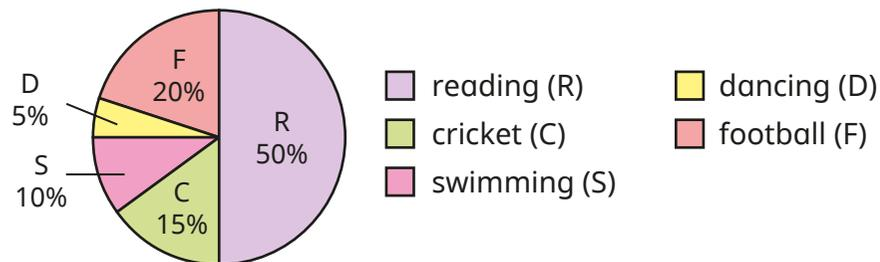

- ▶ How many children chose each activity?
- ▶ How many more children chose football than dancing?

- 1,200 people were asked to name their favourite day of the week.

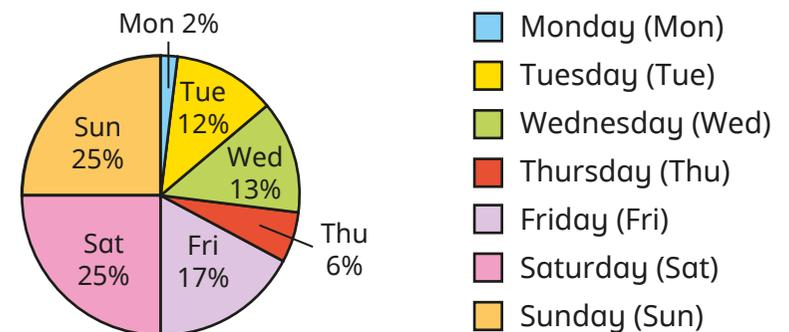

Use the pie chart to create a table showing how many people chose each day of the week.

- 50 people were asked to name their favourite destination.

The results were recorded in this table and a pie chart was drawn.

Destination	People
Legoland	12
Disneyland	21
Thorpe Park	6
Alton Towers	11

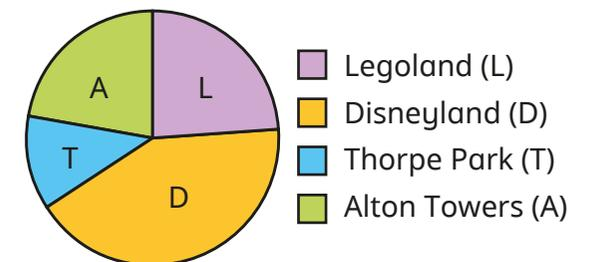

Use the table to help you write the percentages on the pie chart.

Pie charts with percentages

Reasoning and problem solving

120 boys and 100 girls were asked to name their favourite subject.

The results are shown in the pie charts.

boys' favourite subjects

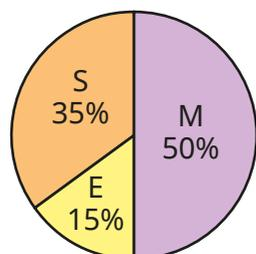

girls' favourite subjects

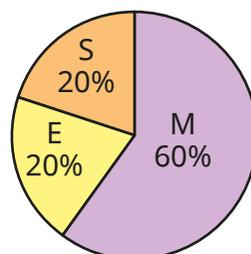

Maths (M)
 English (E)
 Science (S)

More girls prefer maths than boys, because 60% is greater than 50%.



Do you agree with Tiny?

Explain your answer.

No

The pie chart shows the results of a survey about how many siblings people have.

15 people in the survey have no siblings.

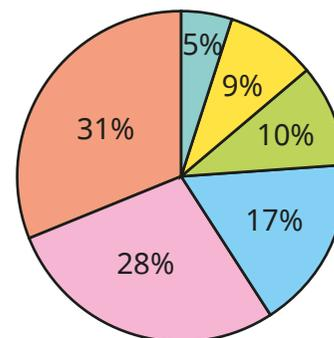

no siblings
 1 sibling
 2 siblings
 3 siblings
 4 siblings
 5 siblings

Draw a table to show how many people each sector of the pie chart represents.

How many people took part in the survey?

No siblings: 15
 1 sibling: 27
 2 siblings: 30
 3 siblings: 51
 4 siblings: 84
 5 siblings: 93

300

Draw pie charts

Notes and guidance

In this small step, children complete their exploration of pie charts by drawing them.

Children recap what a pie chart represents, with the whole being worth 100%. They start by drawing simple pie charts, with each part being worth 50% or 25%, where they can easily see one half and one quarter of the chart. They then move on to constructing pie charts where guidelines are provided, firstly in 10% intervals and then at 1% intervals. Children need to use their conversion skills to work out what percentages are needed.

Finally, children construct pie charts using a protractor. They use division to work out how many degrees represent each item of data, and then multiplication to find the angle for each sector.

Things to look out for

- Children may confuse the angle with the percentage or the number that a sector represents.
- Children may need reminding how to use a protractor.
- When drawing a pie chart using a protractor, children may use the frequency as the size of the angle rather than working out what the angle should be.

Key questions

- What percentage does the whole pie chart represent?
- How can I show _____% of a pie chart?
- How many degrees are there in a full turn?
- If there are _____ in total and a part is _____, what fraction is the part of the whole?
- How can you work out the percentage/angle that represents each sector?
- How do you use a protractor? How do you know which scale to use?

Possible sentence stems

- The fraction/percentage of _____ is _____
- The whole pie chart is _____°
This represents _____ items of data.
Each item of data is represented by _____ ÷ _____ = _____°

National Curriculum links

- Interpret and construct pie charts and line graphs and use these to solve problems

Draw pie charts

Key learning

- 20 cars drove past a school one morning. The table shows the colours of the cars.

Complete the table and show the information on the pie chart.

Colour	Number	Fraction of total	% of total
Red	5		
Blue	5		
Black	10		

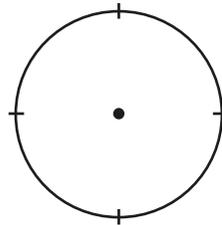

- 100 people were asked to name their favourite ice cream.

The table shows the results.

Use the information to draw a pie chart.

Flavour	Number	Fraction of total	% of total
Chocolate	10	$\frac{1}{10}$	10%
Vanilla	30		
Strawberry	20		
Mint	40		

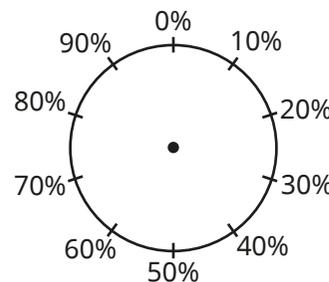

- Draw a pie chart using the data shown in the percentage bar model.

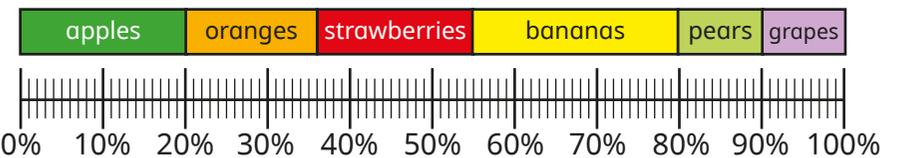

What is the same and what is different about the two diagrams?

- The table shows how 36 children travel to school.

Type of transport	Number of children	Angle
Car	12	$12 \times 10 = 120^\circ$
Bike	7	
Walk	8	
Bus	5	
Scooter	4	
Total	36	360°

Complete the table.

Use a protractor to help you draw a pie chart to show the data.

Draw pie charts

Reasoning and problem solving

Rosie asked the children in Year 6 to name their favourite sport.



The table shows the results.

Complete the table and draw a pie chart to show the information.

Sport	Total	Angle
Football	10	
Tennis	18	
Rugby		_____ × 6 = 90°
Swimming	6	6 × 6 = 36°
Cricket		_____ × 6 = 42°
Golf	4	4 × 6 = 24°
Total	60	360°

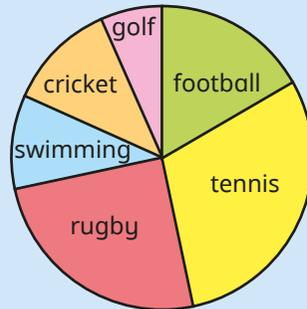

The owner of a restaurant is working out which Sunday dinner is most popular.



Complete the table and draw a pie chart to show the information.

Dinner	Total	Angle
Chicken	2	
Pork	8	
Lamb	6	
Beef	20	180°
Vegetarian	4	
Total		

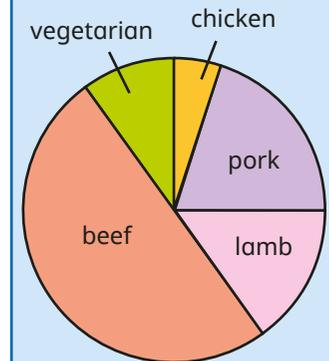

Write some questions about your pie chart for a partner to answer.



The mean

Notes and guidance

In the final small step in this block, children calculate and interpret the mean as an average.

Children may be familiar with the word “average”, but are less likely to have heard of the mean. Begin by discussing what an average is and why averages are useful to summarise sets of data. Explain that the most commonly used average is the mean and show how it is calculated, recapping addition and division skills if necessary. Using simple data in familiar contexts will help children to understand the concept. Using concrete representations to model sharing out items can help children to make sense of the formula: $\text{mean} = \text{total number} \div \text{number of items}$.

When children are confident in finding the mean, they can be challenged to find missing data values if the mean is known. Children need to recognise that the first thing they need to do is to multiply to find the total.

Things to look out for

- Children may make calculation errors in the addition or division.
- Children may need support to realise they can “work backwards” to find the total when the mean is known.

Key questions

- How can you calculate the total number of _____?
- What operation do you use to share equally?
- How can you use the total to calculate the mean?
- Why would you want to find the mean of a set of data?
- For what sets of data would it be useful to calculate the mean?
- How can you use the mean to work out missing information?

Possible sentence stems

- The mean is the size of each part when the whole is shared _____
- The total is _____
There are _____ numbers.
Mean = _____ \div _____

National Curriculum links

- Calculate and interpret the mean as an average

The mean

Key learning

- Three children each drink some glasses of juice.

The table shows a method to find the mean number of glasses of juice that each child had to drink.

Number of glasses per child	Total number of glasses	If each child had the same number of glasses

How does the table show that the mean number of glasses that each child had is 3?

- Work out the mean number of slices of pizza eaten by each child.

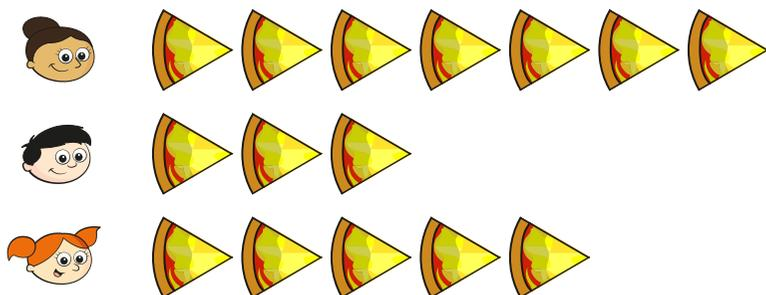

- Here are the number of runs Jack scored in seven cricket matches.

134, 60, 17, 63, 38, 84, 10

Calculate the mean number of runs Jack scored in a match.

- The amount of money raised for charity by five children is shown in the table.

Child	Amount raised
Aisha	£24.55
Sam	£29.60
Tommy	£40
Filip	£21.20
Scott	£19.65

What is the mean amount of money raised by the children?

- Calculate the mean of the numbers.

0.145

0.05

0.28

0.205

The mean

Reasoning and problem solving

The mean number of goals scored in six football matches was 4

Use this information to work out how many goals were scored in the 6th match.

Match	Number of goals
1	8
2	4
3	6
4	2
5	1
6	

3

Rosie takes 5 spelling tests.

Her mean score is 7

What scores might Rosie have got in each spelling test?

Compare answers with a partner

any set of 5 numbers that totals 35

- Mum is 48 years old.
- Scott is 4 years older than James.
- James is 7 years older than Esme.

The average age of pairs of family members are shown.

Mum } — mean age of 50
Dad }

Scott } — mean age of 13
James }

Anna } — mean age of 6
Esme }

Work out the age of each member of the family.

Work out the mean age of the whole family.

Mum: 48 years

Dad: 52 years

Scott: 15 years

James: 11 years

Anna: 8 years

Esme: 4 years

23 years